

HEWLETT-PACKARD

HP ColorPro Graphics Plotter  
**Operating Manual**



FOR  
REFERENCE  
ONLY



---

HP ColorPro Graphics Plotter  
**Operating Manual**



Copyright © Hewlett-Packard Co. 1985, 1987, 1989  
16399 W. Bernardo Drive, San Diego, CA 92127-1899

## **Warranty Statement**

### **One-Year Limited Hardware Warranty**

Except when used as part of an HP system, Hewlett-Packard warrants your graphics peripheral hardware product against defects in materials and workmanship for a period of one year from receipt by the end user. If HP receives notice of such defects during the warranty period, HP will either, at its option, repair or replace products which prove to be defective.

Should HP be unable to repair or replace the product within a reasonable amount of time, customer's alternative exclusive remedy shall be a refund of the purchase price upon return of the product.

If this product was purchased as part of an HP system in a coordinated shipment or as a system add-on, it is warranted against defects in material and workmanship during the same period as the HP system.

### **Exclusions**

The above warranty shall not apply to defects resulting from: improper or inadequate maintenance by customer; customer-supplied software or interfacing; unauthorized modification or misuse; operation outside of the environmental specifications for the product; or improper site preparation and maintenance.

### **Obtaining Warranty Service**

To obtain warranty service, products must be returned to a service facility designated by HP. HP may repair on-site at the option of the customer. Customer is responsible for travel charges when on-site repair is requested.

Warranty service for products purchased as part of a system will be subject to service in accordance with the system support services.

Customer shall prepay shipping charges for products returned to HP for warranty service and HP shall pay for return of the products to customer. However, customer shall pay all shipping charges, duties, and taxes for products returned to HP from another country.

### **Warranty Limitations**

HP makes no other warranty, either expressed or implied, with respect to this product. HP specifically disclaims the implied warranties of merchantability and fitness for a particular purpose. Some

states or provinces do not allow limitations on the duration of an implied warranty, so the above limitation or exclusion may not apply to you. However, any implied warranty of merchantability or fitness is limited to the one-year duration of this written warranty.

This warranty gives you specific legal rights, and you may also have other rights which may vary from state to state, or province to province.

#### **Exclusive Remedies**

The remedies provided herein are customer's sole and exclusive remedies. In no event shall HP be liable for any direct, indirect, special, incidental, or consequential damages, whether based on contract, tort, or any other legal theory. Some states or provinces do not allow the exclusion or limitation of incidental or consequential damages, so the above limitation or exclusion may not apply to you.

#### **Obtaining Service During or After Warranty**

##### *During the Warranty Period*

If your hardware should fail during the warranty period, follow the test procedures in the system manuals, then bring the failed piece of equipment to an Authorized HP Personal Computer Dealer Repair Center — or send the equipment to one of the HP Field Repair Centers listed in the directory sent with your product. (HP may repair on-site at your option, in which case you are responsible for travel charges.)

##### *After the Warranty Period*

If your hardware should fail after the warranty period, follow the test procedures in the system manuals, then contact an Authorized HP Personal Computer Dealer Repair Center or call your HP Sales and Service Office for details of the services available.

If you are uncertain about which unit to return, call your Authorized HP Personal Computer Dealer or a Field Repair Center for assistance.

**When sending equipment to a Field Repair Center, please follow the procedure in *Returning Your Plotter for Service*, in this manual.**

## How to Use This Manual

This *Operating Manual* contains all the information you should need to connect your plotter to a computer and create color graphics using a graphics software package.

To use this manual:

- Follow the instructions in Chapter 1, *Setting Up Your Plotter*, to set up your plotter, load pens and paper, and run the built-in demonstration plot.
- Read Chapter 3, *Connecting Your Plotter to a Computer*. This chapter tells you how to get your plotter hooked up to a computer for running graphics software.
- Read the information in Chapter 4, *Creating Graphics on Your Plotter*, to learn how to use graphics software packages or computer programs with your plotter and computer.

After you've successfully set up your plotter and used it with a computer, read over the material in Chapter 2, *Using the Plotter Controls*; Chapter 5, *Selecting Plotter Papers and Pens*; and Chapter 6, *Plotter Maintenance*. These chapters contain additional information about using and maintaining your plotter.

### Manual Terms and Conventions

We've tried to avoid using "computer jargon" in this manual. Computer terminology, when used, appears in italics when it is introduced; the italicized terms are also defined in the manual glossary. Refer to the glossary whenever you are unfamiliar with a word.

Words in this manual that appear in small **BOLDFACE** type refer to pushbuttons or switches located on the plotter.

## Notes

---

## Table of Contents

|   |      |
|---|------|
| <b>Chapter 1: Setting Up Your Plotter</b> .....               | 1-1  |
| What You'll Learn in This Chapter .....                       | 1-1  |
| Plotter Features (Front View) .....                           | 1-3  |
| Plotter Features (Rear View) .....                            | 1-4  |
| Installing the Graphics Enhancement Cartridge .....           | 1-4  |
| Connecting the Power Supply .....                             | 1-5  |
| Turning Your Plotter On .....                                 | 1-6  |
| Loading Pens .....  | 1-7  |
| Inserting the Pen Carousel .....                              | 1-10 |
| Loading Paper or Transparency Film .....                      | 1-11 |
| Performing the Demonstration Plot .....                       | 1-12 |
| Plotter Symptoms and Solutions .....                          | 1-14 |
| <br>  |      |
| <b>Chapter 2: Using the Plotter Controls</b> .....            | 2-1  |
| What You'll Learn in This Chapter .....                       | 2-1  |
| Control-Panel Button Functions .....                          | 2-1  |
| The On/Off Button .....                                       | 2-4  |
| The Load Button .....   | 2-4  |
| The Pen Control Buttons .....                                 | 2-4  |
| The Pen Select Button .....                                   | 2-5  |
| The Cursor Control Buttons .....                              | 2-5  |
| The Pen Up/Down Button .....                                  | 2-6  |
| The View Button .....   | 2-6  |
| The P1 and P2 Buttons .....                                   | 2-6  |
| Positioning P1 and P2 .....                                   | 2-7  |
| Rotating Plots .....  | 2-8  |
| The Enter Button .....  | 2-10 |
| Digitizing .....  | 2-10 |
| <br>  |      |
| <b>Chapter 3: Connecting Your Plotter to a Computer</b> ..... | 3-1  |
| What You'll Learn in This Chapter .....                       | 3-1  |
| An Introduction to Plotter/Computer Graphics .....            | 3-1  |
| Using the Computer/Plotter Interconnection Instructions ..... | 3-2  |
| Configuring Your Computer System .....                        | 3-2  |
| The Test Program .....  | 3-3  |
| Plotter Interface Types .....                                 | 3-4  |
| List of Computer/Plotter Interconnections .....               | 3-4  |
| If Your Computer Isn't Listed .....                           | 3-5  |
| Plotter/Computer Symptoms and Solutions .....                 | 3-5  |
| Apple IIe or II Plus Computer .....                           | 3-7  |
| Apple IIc Computer .....                                      | 3-10 |
| Apple III Computer .....                                      | 3-13 |

## Table of Contents (Continued)

### Chapter 3: Connecting Your Plotter to a Computer (Continued)

|  |      |
|--|------|
| Apple Macintosh/Macintosh Plus/II/SE .....                           | 3-16 |
| Commodore Amiga Personal Computers .....                             | 3-18 |
| DEC Professional 350 Computer .....                                  | 3-21 |
| HP Portable Computer (HP-IB Interface) .....                         | 3-24 |
| HP Portable Computer .....   | 3-27 |
| HP Series 200 Personal Technical Computer<br>(HP-IB Interface) ..... | 3-30 |
| HP Touchscreen Personal Computer (HP-IB Interface) .....             | 3-32 |
| HP Touchscreen Personal Computer .....                               | 3-35 |
| Personal Computers .....   | 3-38 |
| Olivetti M24 Computer .....  | 3-41 |
| Sirius 1 Computer .....  | 3-43 |

|   |     |
|---|-----|
| <b>Chapter 4: Creating Graphics On Your Plotter</b> ..... | 4-1 |
| What You'll Learn in This Chapter .....                   | 4-1 |
| Using Graphics Software Packages .....                    | 4-1 |
| For RS-232-C Interface Users .....                        | 4-2 |
| For HP-IB Interface Users .....                           | 4-3 |
| Writing Your Own Graphics Programs .....                  | 4-4 |
| Plotter/Software Symptoms and Solutions .....             | 4-5 |

|   |     |
|---|-----|
| <b>Chapter 5: Selecting Plotter Papers and Pens</b> ..... | 5-1 |
| What You'll Learn in This Chapter .....                   | 5-1 |
| Paper and Pen Combinations .....                          | 5-1 |
| Plotter Paper .....                                       | 5-2 |
| Glossy Presentation Paper .....                           | 5-2 |
| Overhead Transparency Film .....                          | 5-2 |
| Plotter Pens .....  | 5-3 |
| Storing Plotter Pens .....                                | 5-4 |
| Pen Speed .....   | 5-4 |
| Paper/Pen Symptoms and Solutions .....                    | 5-5 |

|   |     |
|---|-----|
| <b>Chapter 6: Plotter Maintenance</b> .....     | 6-1 |
| What You'll Learn in This Chapter .....         | 6-1 |
| Plotter Maintenance .....                       | 6-1 |
| Cleaning the Plotter .....                      | 6-1 |
| Cleaning the Pen Carousel .....                 | 6-2 |
| Determining If Your Plotter Needs Service ..... | 6-3 |
| Returning Your Plotter for Service .....        | 6-3 |



## Table of Contents (Continued)

|   |      |
|---|------|
| <b>Appendix A: Specifications</b> .....                       | A-1  |
| List of Specifications .....                                  | A-1  |
| Functional .....  | A-1  |
| Interface Options .....                                       | A-2  |
| Physical .....  | A-2  |
| Environmental .....   | A-2  |
| Power .....   | A-3  |
| <b>Appendix B: Supplemental Interfacing Information</b> ..... | B-1  |
| RS-232-C/CCITT V.24 Information .....                         | B-2  |
| Baud Rate Options .....                                       | B-2  |
| Parity Options .....  | B-2  |
| Plotter Interface Connector .....                             | B-3  |
| Cable Schematics .....  | B-4  |
| Handshake Information .....                                   | B-6  |
| HP-IB Information .....                                       | B-7  |
| Address/Mode Options .....                                    | B-7  |
| <b>Appendix C: The Graphics Enhancement Cartridge</b> .....   | C-1  |
| Installing the Cartridge .....                                | C-2  |
| <b>Appendix D: Accessories Available</b> .....                | D-1  |
| List of Accessories Available .....                           | D-1  |
| The Programming Manual .....                                  | D-2  |
| How to Order Supplies and Accessories .....                   | D-3  |
| <b>Glossary</b> .....   | G-1  |
| <b>Subject Index</b> .....                                    | SI-1 |

CHAPTER

1

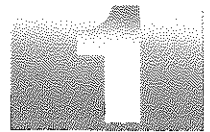

# Setting Up Your Plotter

## What You'll Learn in This Chapter

This chapter shows you how to set up your plotter, load pens and paper, and run the built-in demonstration plot.

### Initial Inspection

Your plotter and its accessories were inspected before the unit was shipped from Hewlett-Packard, and everything should be in good operating order. Carefully unpack and inspect your plotter and its accessories. Save the carton and packing materials in case you ever need to ship your plotter. If your plotter is received in damaged condition, notify the dealer or HP Sales and Support Office where you purchased the plotter, and file a claim with the carrier.

Compare your accessories with those listed in the following table. If any are missing, contact the dealer or HP Sales and Support Office where you purchased the plotter.

*Accessories Supplied*

| Item  | Quantity | HP Part Number |
|---|----------|----------------|
| Operating Manual (language based on destination)  | 1        |                |
| English   |          | 07440-90002    |
| German  |          | 07440-90004    |
| French  |          | 07440-90005    |
| Spanish   |          | 07440-90006    |
| Italian   |          | 07440-90007    |
| Japanese  |          | 07440-90008    |
| Power Supply (configured for plotter destination) | 1        | See Appendix A |
| 8-pen Carousel                                    | 1        | 07440-60085    |
| Sample packages of pens and paper                 | —        | —              |

**NOTE:** An interface cable (required to connect the plotter to a computer) is *not* included with your plotter and must be purchased separately. Refer to Chapter 3 to determine which interface cable is required for your computer. ■

## Plotter Features (Front View)

Look at the front of your plotter and identify the features numbered in the following figure.

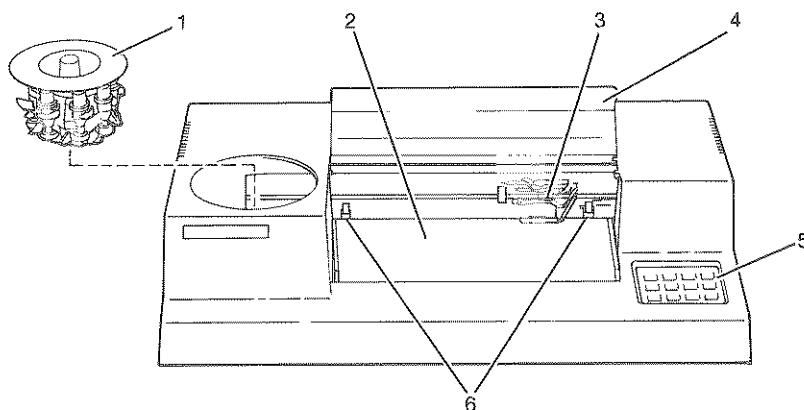

1. **Pen Carousel (removable)** — Holds up to eight pens for multicolor plotting.
2. **Platen** — Provides a firm surface for plotting.
3. **Pen Holder** — Selects, moves, and puts away pens during plotting.
4. **Carriage Cover** — Prevents objects from blocking pen motion during plotting.
5. **Control Panel** — Includes the buttons used to manually control various plotter functions. (Button functions are described in Chapter 2.)
6. **Pinch Wheels** — Hold paper in place and move it back and forth during plotting.

## Plotter Features (Rear View)

Look at the back of your plotter and identify the features numbered in the following figure.

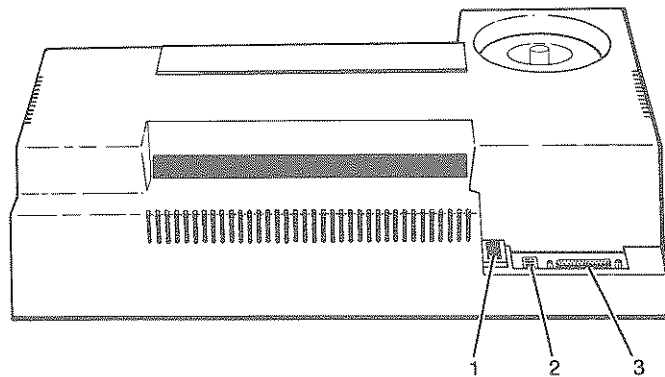

1. **Power Socket** — Accepts the power cable connector from the power supply.
2. **Interfacing and Paper-Size Switches** — Used to select either English ( $8\frac{1}{2} \times 11$  in.) or metric ( $210 \times 297$  mm) paper, and to establish interfacing conditions when connecting the plotter to a computer.
3. **Interface Connector** — Accepts the interface cable used to connect the plotter to a computer.

## Installing the Graphics Enhancement Cartridge

An add-on cartridge is available for your plotter that will enhance its graphics capabilities. If you have purchased an HP Graphics Enhancement Cartridge (HP 17440) for your plotter, refer to Appendix C at this time for installation instructions.

## Connecting the Power Supply

Your plotter's wall power plug and power supply are configured for the power specifications of the country to which it was shipped. Check the voltage tag on your power supply to be certain that the listed input voltage matches your ac power source.

If your power supply has the wrong voltage or wall power plug for your requirements, refer to Appendix A for a list of available power supply options. Contact your authorized dealer or local HP Sales and Support Office for information on obtaining the correct power supply.

Connect the power supply as shown in the following figure and described by steps 1 through 3.

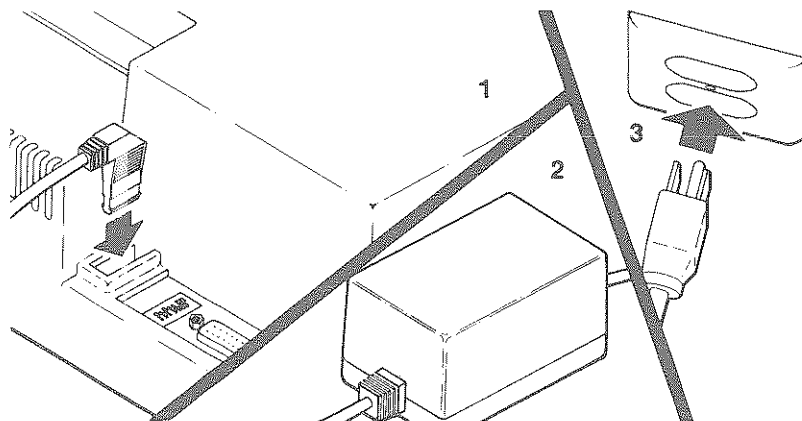

### WARNING

The plotter power supply should be used with a properly grounded receptacle to avoid electrical shock.

1. Insert the small connector on the power supply's cord into the power socket on the back of your plotter. Press down on the connector until it snaps into place.
2. Place the plotter's power supply on the table near your plotter.

3. Plug the wall power plug on the power supply's cord into a grounded power outlet.

**NOTE:** Should the power supply interfere with your computer's video monitor, move the power supply away from the monitor. ■

## Turning Your Plotter On

To turn your plotter on, simply press the **ON/OFF** button as shown in the following figure. When the plotter is turned on, the indicator light directly above the **ON/OFF** button turns on. In addition, the plotter *initializes*, indicated by movement of the pen holder and carousel. (Initialization simply means that certain standard conditions are established within the plotter.)

Press the **ON/OFF** button a second time to turn the plotter and indicator light off.

---

### CAUTION

The **ON/OFF** button does not turn off the power supply. Voltage is present at the connector while the supply is plugged in.

---

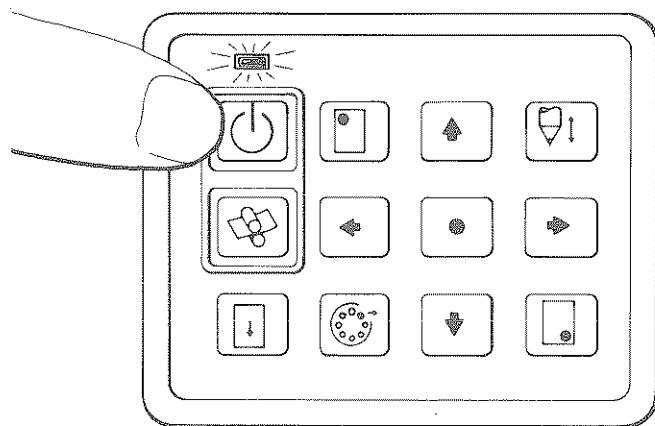



## Loading Pens

Your plotter can access as many as eight different pens when plotting. Pens are stored in stalls (numbered 1-8) on the pen carousel. You can place pens of any color into the pen stalls. If you will be using a graphics software package, note which pen color you place in each stall number so you can indicate to your software which pen you wish to use for various parts of your plot.

To load pens into the pen carousel:

1. Open the two packages of paper (fiber-tip) pens and save the packages for storing unused pens. Note that the ink color for each pen matches the color of the markings on the top of the pen. The number on the top of a pen specifies the line width (in tenths of millimetres) that the pen will draw. Choose a pen for each carousel pen stall you want to use.

The following table shows the pen colors recommended for plotting the plotter's built-in demonstration plot, which you will learn to run later in this chapter.

*Recommended Pens for Demo Plot*

| Pen Stall Number | Pen Type and Color |
|------------------|--------------------|
| 1                | P.3, black         |
| 2                | P.3, red           |
| 3                | P.3, blue          |
| 4                | P.3, yellow        |
| 5                | P.3, green         |
| 6                | P.3, violet        |
| 7                | P.3, aqua          |
| 8                | P.3, orange        |

2. Remove the plastic caps from the pens you've selected. Save the caps for storing pens when they aren't in the carousel.
3. Remove the carousel from the plotter.

4. Hold the carousel in one hand as shown in the following illustration. Then follow steps a through c.
  - a. Turn the carousel so that a numbered stall is facing you. Use the index finger of the same hand to pull down the stall's pen cap lever.

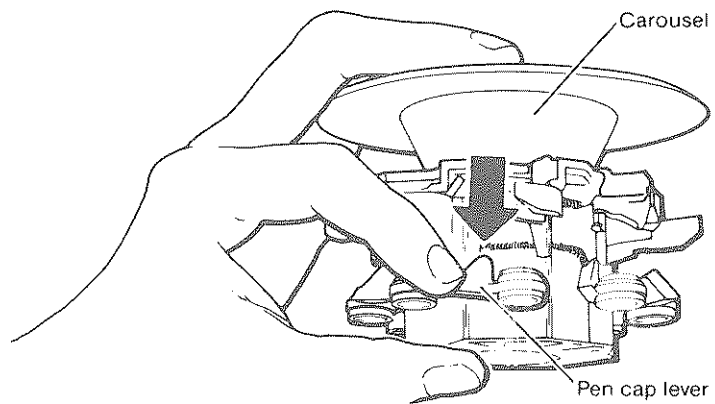

- b. Pick up the pen you have chosen for the pen stall with your other hand. Insert the pen into the pen stall's pen-holding jaws until the jaws close around the pen. The collar on the pen should rest on top of the jaws.

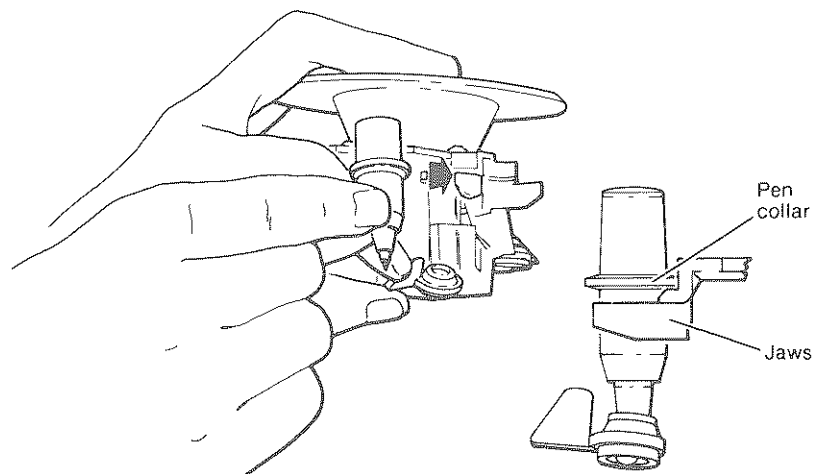

- c. Release the pen cap lever slowly to let the rubber pen cap cover the pen tip.

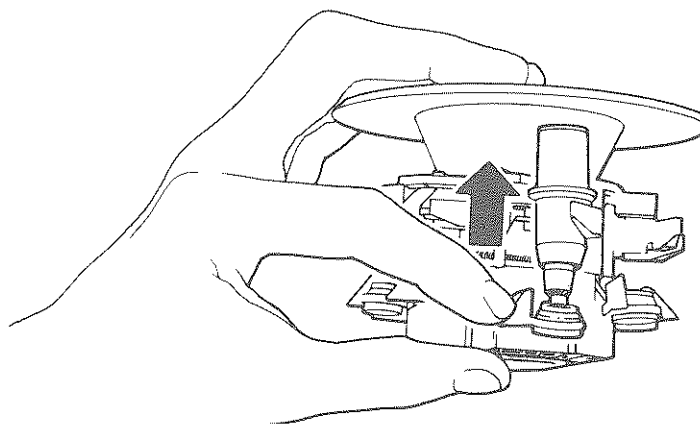

Repeat step 4 for each pen stall you want to use. To remove a pen, reverse the loading procedure.

## Inserting the Pen Carousel

The pen carousel fits on a rotating spindle located in the round opening on the left side of the plotter. You can easily remove or insert the carousel to load or unload pens. To insert the carousel, refer to the following figure and steps.

1. Turn on the plotter. This rotates the carousel spindle to a standard loading position.

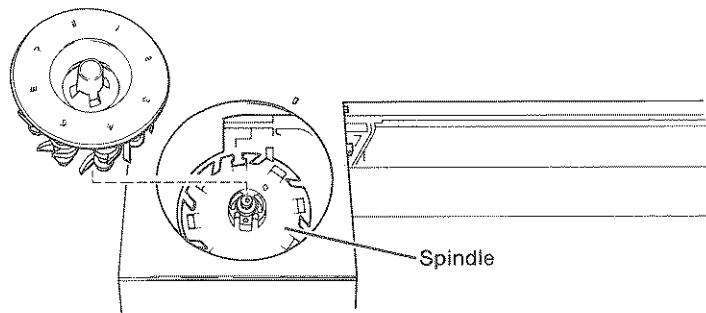

2. Place the carousel on the spindle so that the triangular marker on the plotter points towards the pen stall #1 on the carousel. If necessary, turn the carousel gently until it slips into place.

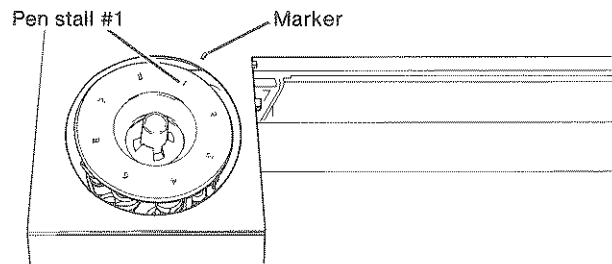

## Loading Paper or Transparency Film

You can create plots on regular plotter paper, glossy presentation paper, or transparency film. Detailed information on using these different media is provided in Chapter 5, *Plotter Pens and Paper*.

**NOTE:** The word *paper* is used throughout this manual to refer to transparency film as well as plotter and glossy presentation paper. ■

Your plotter can use paper in two sizes:

- 8.5 × 11 in. (English, ANSI A-size)
- 210 × 297 mm (metric, ISO A4-size)

To load paper or transparency film:

1. Locate the US/A4 paper-size switch on the plotter's rear panel, shown in the figure below. With the plotter turned off, use the tip of a pencil or ball point pen to set the switch to the paper size you are using. Select the US switch position for 8.5- × 11-in. paper and the A4 switch position for 210- × 297-mm paper.

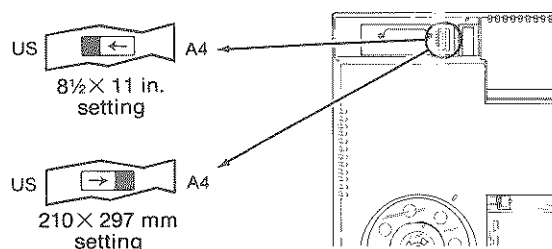

*The Paper-Size Switch*

**NOTE:** The plotter “reads” the position of the rear-panel switches only when you turn it on. Changes made in the switch position while the plotter is on are not read unless the power is “cycled” (turned off and then on). ■

2. Turn the plotter on. Then lay a sheet of paper on the platen, placing the paper's long side against the platen's left rail. Slide the paper back until the rear edge of the paper is flush with the white line on the platen. (Refer to the following figure.)

To load transparency film, leave the paper backing on the film and load the film with the paper side against the platen.

3. Press the **LOAD** button. The pinch wheels will lower and the paper will be moved back and forth one time to prepare it for plotting.

To unload paper, press the **LOAD** button a second time. This releases the pinch wheels and frees the paper.

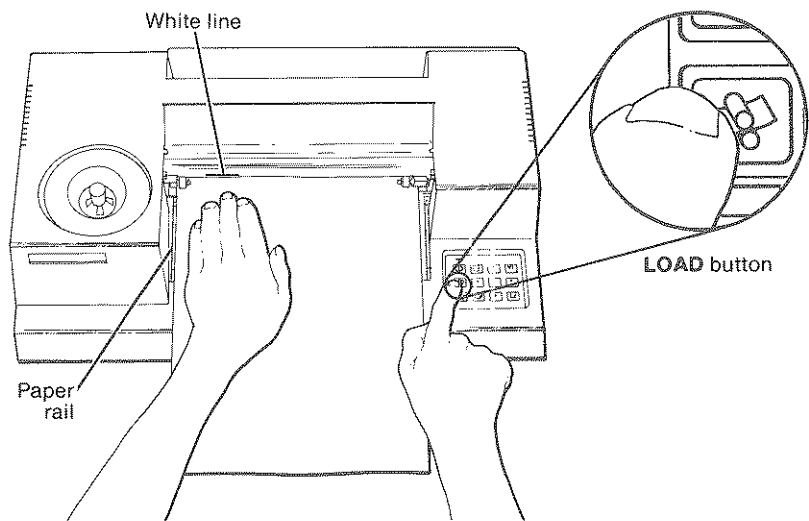

*Loading Paper*

## Performing the Demonstration Plot

Your plotter has a built-in demonstration plot that can be started using the control-panel buttons. Because the plot uses many plotter features and operations, the plot can be used as a confidence test. If the plot is completed there is a high probability that the plotter is functioning properly.

Before starting the plot, make sure pens, carousel, and a sheet of paper have been loaded properly. To start the plot, *hold down* the **ENTER** button and press the **LOAD** button. Refer to the following figure.

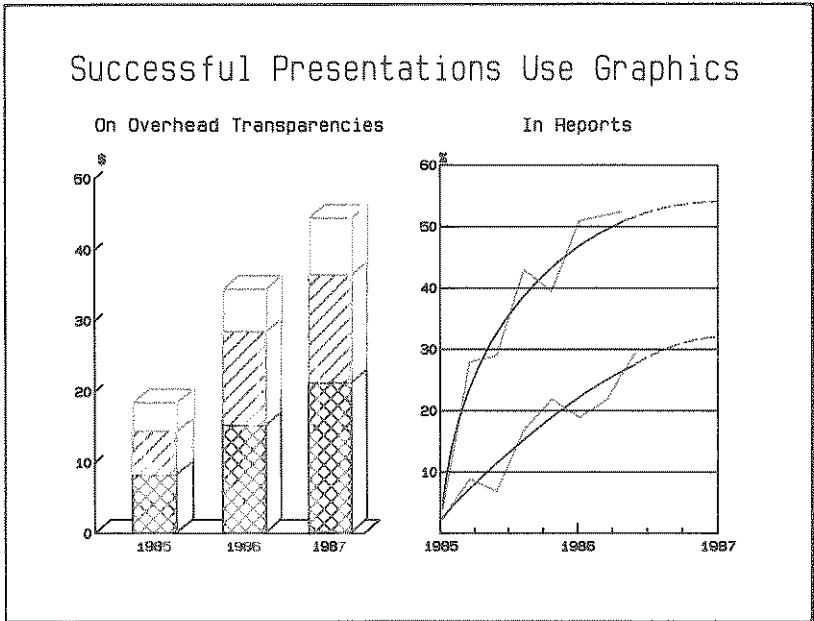
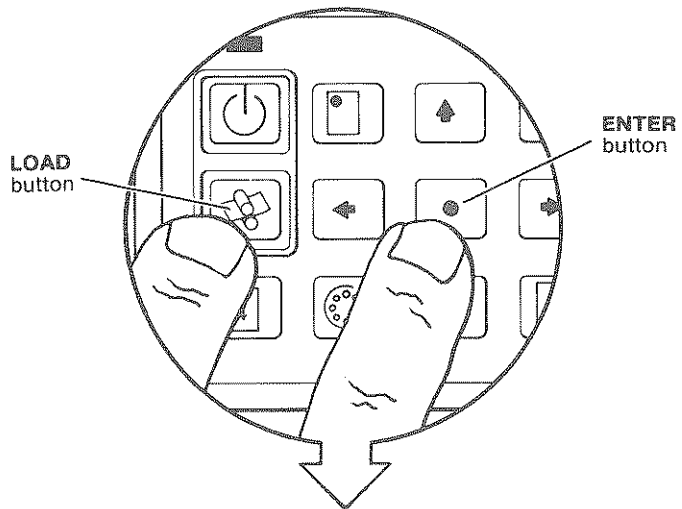

**NOTE:** If you have installed a Graphics Enhancement Cartridge in your plotter, the demonstration plot will appear as shown in Appendix C. ■

*The Demonstration Plot*

Press **LOAD** again to unload the plot.

## Plotter Symptoms and Solutions

Use the following table if you are having problems with your plotter only (no computer interface attached). If you are having problems using the plotter with a computer, refer to the *Plotter/Computer Symptoms and Solutions* table in Chapter 3.

| Symptom   | Possible Cause   | Solution   |
|---|--|--|
| Plotter doesn't respond when the ON/OFF button is pressed.                  | No voltage at wall outlet.                               | Check power source.  |
|   | Power supply connector unplugged from plotter.           | Reinsert connector.  |
|   | Fluctuation in AC line voltage.                          | Unplug the plotter power supply from the wall outlet, then plug it back in. Try using the plotter again.       |
|   | Power supply or plotter damaged.                         | See <i>Returning Your Plotter for Service</i> in Chapter 6.  |
| Plotter turns itself off immediately after being turned on.                 | Pen holder path obstructed by stray pen or other object. | Remove object.   |
| Plotter responds when turned on, but other front panel controls don't work. | Paper has not been loaded.                               | Paper must be loaded before using other buttons. Refer to Chapter 3 for instructions on using plotter buttons. |
|   | Plotter is temporarily "locked-up."                      | Reinitialize the plotter by turning it off and then on again.  |
|   | Plotter damaged.   | See <i>Returning Your Plotter for Service</i> in Chapter 6.  |

(Table continues)



| Symptom   | Possible Cause                             | Solution   |
|---|--|--|
| Plotter responds to buttons, but demonstration plot doesn't work or is drawn incorrectly. | Improper button sequence being used.       | Make certain you are holding the <b>ENTER</b> button down when you press the <b>LOAD</b> button. |
|   | Pens loaded improperly or pens out of ink. | Make sure pens are loaded properly.  |
|   | Plotter damaged.                           | See <i>Returning Your Plotter for Service</i> in Chapter 6.                                      |

CHAPTER

2

## Using the Plotter Controls

### What You'll Learn in This Chapter

This chapter explains the functions of the control-panel buttons and shows you how to use them. If you want to connect your plotter to your computer right away, turn to Chapter 3. Then return to this chapter when you are ready to learn about using the plotter buttons.

### Control-Panel Button Functions

The buttons on your plotter can be used to perform the following functions:

- Turn the plotter on and off.
- Load and unload paper.
- Manually control pen selections and movement.
- Temporarily halt plotting to view the plot or change pens without losing plot data.
- Manually change the scaling or position of plots when writing or using graphics programs.

If you will be using a graphics software package, you normally will only need to use the control-panel buttons to turn your plotter on and off and to load and unload paper. Most software packages automatically control pen selections, pen motion, and the scaling





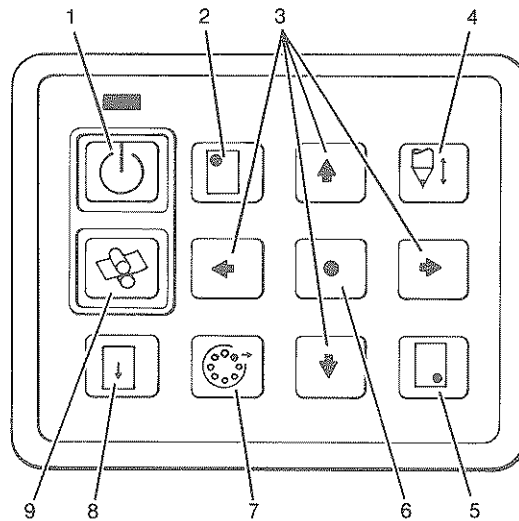



and positioning of plots. Reading this chapter, however, will show you when and how to use the other buttons.

The following figure shows the plotter buttons. Each button is marked by an international symbol and is numerically keyed to the table of button descriptions on the next page.



*Control-Panel Buttons*

*Control-Panel Buttons*

| Button Symbol  | Button Name  | Function  |
|--|--|---|
| 1.    | <b>ON/OFF</b>  | Turns the plotter on and off.   |
| 2.    | <b>P1</b>  | Locates or repositions P1 (a scaling point on the plot).  |
| 3.    | <b>CURSOR CONTROLS</b><br>(Four buttons with arrows) | Moves the pen over the paper in the direction of arrow.   |
| 4.   | <b>PEN UP/DOWN</b>                                   | Raises and lowers the pen.  |
| 5.  | <b>P2</b>  | Locates or repositions P2 (a scaling point on the plot).  |
| 6.  | <b>ENTER</b>   | Pressed with <b>LOAD</b> starts the demo plot. Pressed with <b>P1</b> enters the pen location as the new P1. Pressed with <b>P2</b> enters the pen location as the new P2. Pressed with <b>PEN SELECT</b> puts the pen away. Pressed with <b>VIEW</b> rotates the plot orientation. |
| 7.  | <b>PEN SELECT</b>                                    | Manually selects a pen. Pressed with <b>ENTER</b> puts the pen away.  |
| 8.  | <b>VIEW</b>  | Halts plotting and moves the paper to the front of the platen. When pressed again, resumes plotting.  |
| 9.  | <b>LOAD</b>  | Loads and unloads paper.  |

## The On/Off Button



The **ON/OFF** button is explained in Chapter 1. Use this button to turn your plotter on and off. Refer to Chapter 1 if you have not used the **ON/OFF** button.

Turning off the plotter will stop any active plotting. In addition, the plotter's "buffer" (the internal memory used to store the computer-issued plotting instructions) is emptied of any unexecuted instructions.

**NOTE:** The **ON/OFF** button can be used as a "hard reset" button if the plotter becomes hung-up or will not respond to front-panel or software-issued instructions — simply cycle the power by turning the plotter off and then on again. Turning the power off empties the plotter's buffer. ■

## The Load Button



The **LOAD** button is explained in Chapter 1. If you haven't already loaded paper in your plotter, refer to Chapter 1 for instructions. Remember that the **LOAD** button must also be used to unload paper. The plotter automatically puts the currently selected pen away when you unload paper.

**NOTE:** A sheet of paper must be loaded before any other buttons (except **ON/OFF**) can be used. ■

## The Pen Control Buttons

When you are using a software package or computer program with your plotter, the pens are normally controlled automatically and you won't need to use the pen control buttons. There may be occasions, however, when you want to control pens manually from the front panel.

Six front-panel buttons can be used to control the pens. They are the **PEN SELECT** button, the four **CURSOR CONTROL** buttons, and the **PEN UP/DOWN** button. These buttons are described in the following paragraphs.

### The Pen Select Button



The **PEN SELECT** button can be used to select a pen from the carousel. Pressing the button briefly and then releasing it causes the pen holder to return the currently selected pen (if it is holding one) and select the next-highest numbered pen. After retrieving a pen, the pen holder will return to its previous position.

To select a pen other than the next-highest one, hold down the **PEN SELECT** button. The plotter will sequentially pick pens. Release the **PEN SELECT** button when the pen you want has been picked.

**NOTE:** Movement of the paper during pen selection is normal. ■

To return a selected pen to the carousel, hold down the **ENTER** button and press the **PEN SELECT** button.

### The Cursor Control Buttons



The **CURSOR CONTROL** buttons can be used to move the selected pen. Pressing a single button moves the pen in the direction of the arrow marked on the button. Pressing adjacent buttons moves the pen at a 45-degree angle between the two arrow directions.

If a cursor control button is held down for longer than one second, the pen-positioning speed is increased. Press a button briefly to slowly move the pen when positioning the pen precisely over a point.

### The Pen Up/Down Button



The **PEN UP/DOWN** button can be used to raise and lower the pen. Press the button to lower the pen when the pen is up, or to raise the pen when the pen is down. You don't need to hold the button down; simply press it briefly and then release it. You can draw

straight lines manually by lowering the pen and then using the **CURSOR CONTROL** buttons.

If the pen is down and the plotter doesn't receive any commands (either from the buttons or from software) within a five-second period, the pen will be automatically lifted from the paper.

### The View Button

Use the **VIEW** button to temporarily halt a plot in progress. Pressing this button moves the plot so it is fully extended. In this position, you may manually substitute different pens or view the progress of a plot.

When you want to view a plot, hold the **VIEW** button down until the plotter responds by lifting the pen and extending the plot for viewing. To continue with the plot, press the **VIEW** button again. This returns the pen to its previous position. If a plot was in progress, it resumes.

### The P1 and P2 Buttons

*P1* and *P2* can be thought of as two points that can be positioned on the paper to determine the size and location of plots. You will probably never need to position *P1* and *P2*, unless you are writing your own programs or your software package allows you to do so.

Your software package's documentation will tell you if you need to use the *P1* and *P2* buttons. If you are writing your own graphics programs, refer to the HP ColorPro Programming Manual (Part No. 07440-90001) for a detailed explanation on using the *P1* and *P2* points.

If you wish, you can move on to Chapter 3 and come back to this section if you need to position *P1* and *P2*.



## Positioning P1 and P2

Press the **P1** button to raise the pen and move it to a position directly above the current P1 position. Similarly, press the **P2** button to move the pen directly above the current P2 position. When the plotter is first turned on, P1 and P2 are located at their initial default positions as shown in the following figure.

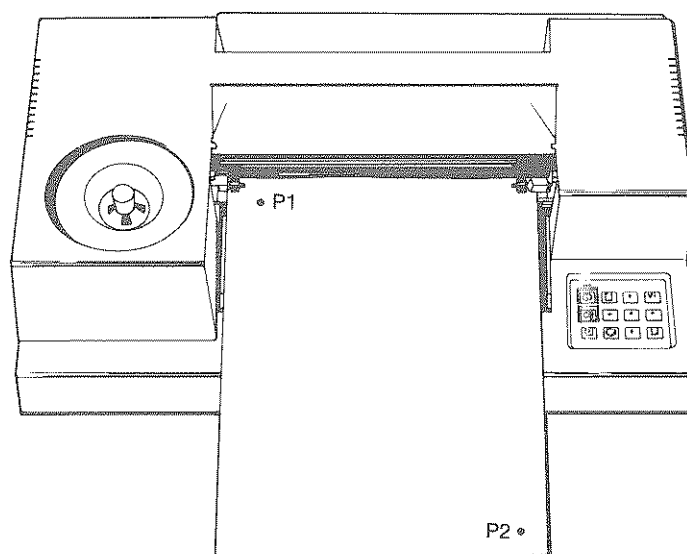

*Initial Positions of P1 and P2*

To reposition P1 or P2, follow these steps while referring to the next illustration:

1. Use the **CURSOR CONTROL** buttons to move the pen to the desired P1 point.
2. Hold down the **ENTER** button and press the **P1** button to enter the new P1.

To position P2, repeat steps 1 and 2 using the P2 button instead of P1.

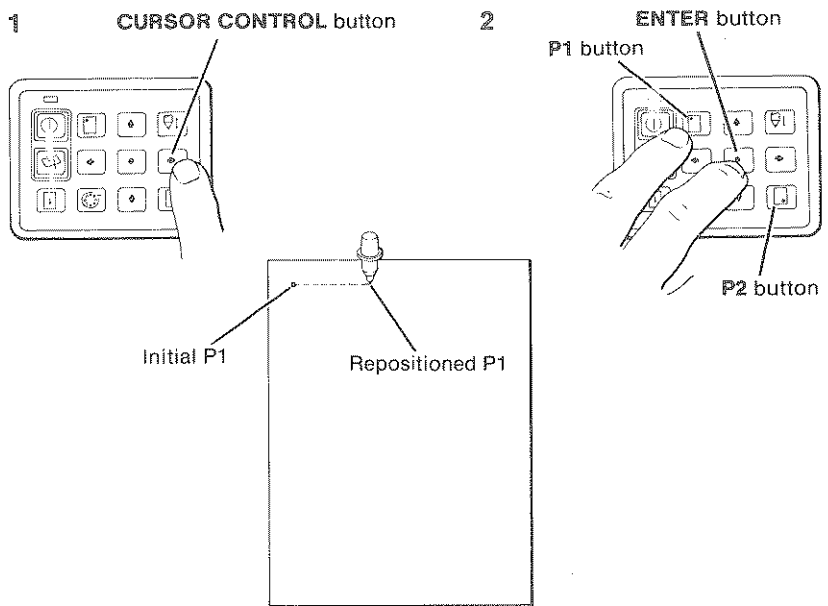

*Positioning P1 or P2*

**NOTE:** When you position P1, the P2 point automatically moves with P1 so that their relative distance and orientation is maintained. Because of the simultaneous movement, you should always position P1 before positioning P2. ■

## Rotating Plots

Following plotter power-up, plots are drawn so that they are oriented horizontally (relative to the long side of the paper). You can also position plots vertically by using the front-panel buttons. Doing so effectively rotates plots by 90°, as shown in the following illustration.

To perform a “front-panel rotation” hold down the **ENTER** button and press the **VIEW** button. The plot orientation will be changed from horizontal to vertical. Pressing **ENTER + VIEW** a second time returns the plot orientation to horizontal. (Performing a front-panel rotation has no effect on the plotter’s built-in demonstration plot.)

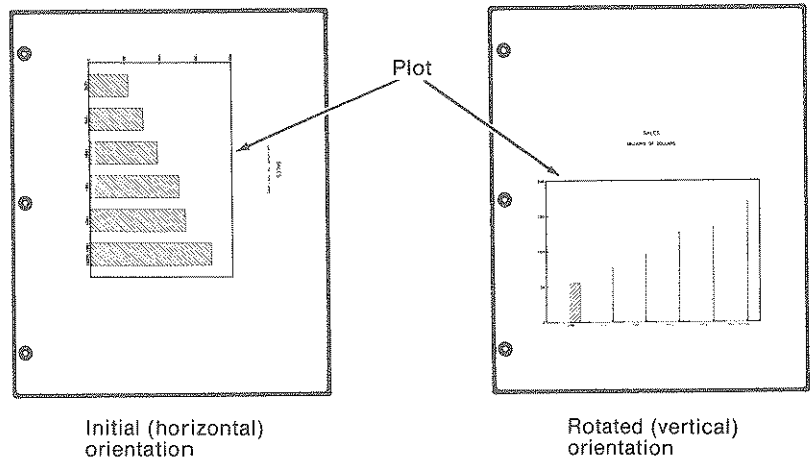











If you are using a graphics software package with your plotter, the rotation of plots may be controlled through the software, and you won’t need to use the front-panel buttons for rotation. Check with your software manual to determine how plot rotation is accomplished by the software.

If you are writing your own graphics programs and need to rotate or reposition plots, refer to Chapter 9, *Changing the Plotting Area*, in the HP ColorPro Programming Manual.

## The Enter Button

This button has a variety of uses which have been discussed previously in this manual. The following chart provides a summary of the ENTER button's functions. In each case, the ENTER button must be held down while the other button is pressed.

| Buttons Used  | Resulting Function                  |
|---|-------------------------------------|
|  +      | Performs the demonstration plot.    |
|  +    | Puts the current pen away.          |
|  +  | Defines current pen position as P1. |
|  +  | Defines current pen position as P2. |
|  +  | Rotates plot orientation.           |

## Digitizing

If you are using a digitizing software package, complete the following steps to digitize with the plotter. Refer to the Programming Manual to write your own digitizing programs.

1. Install your software package, as directed by the software documentation.
2. Load a pen into the carousel.
3. Press the **PEN SELECT** button corresponding to the carousel stall number where you put the pen.
4. When the software prompts you, press the **PEN UP/DOWN** button to raise the pen. Then, use the **CURSOR CONTROL** buttons to position the pen directly over the point you want to digitize.

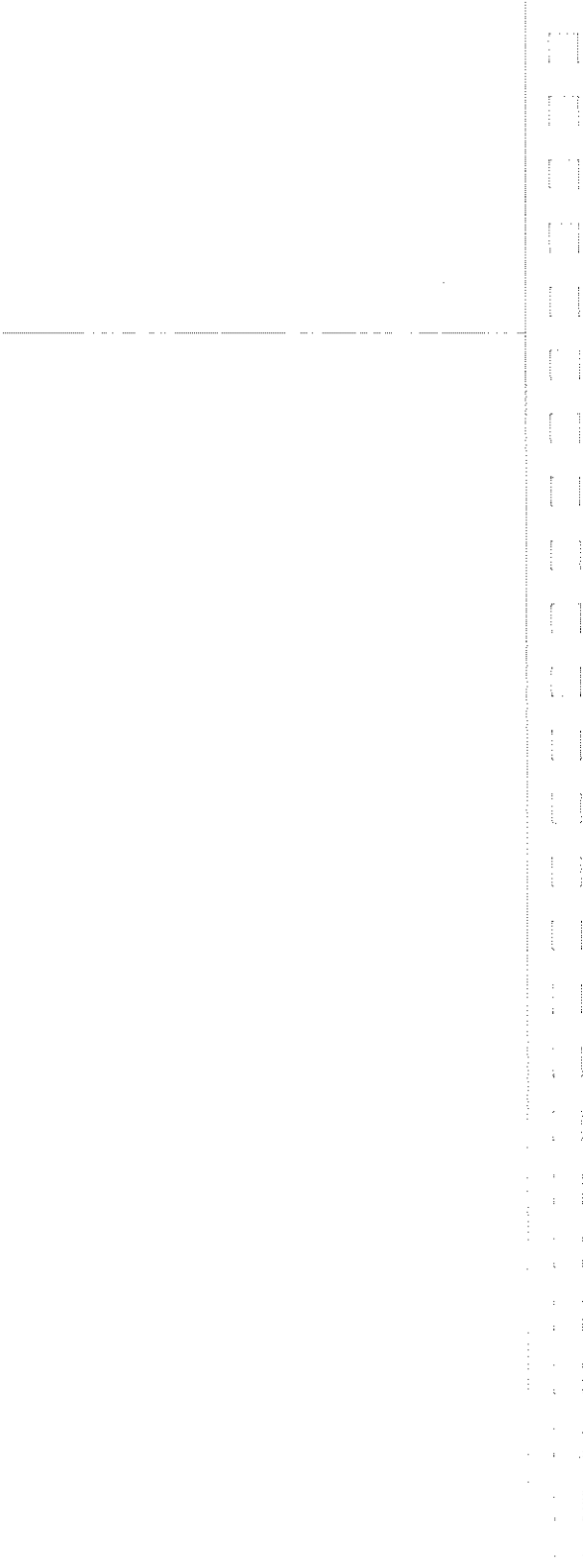
- 
5. For greatest accuracy, press the **PEN UP/DOWN** button to lower the pen when it is in the correct position.
  6. Press the **ENTER** button to send the point to the computer. Depending on your software's requirements, you may need to press a key such as **RETURN** on your computer's keyboard.

CHAPTER

3



## Connecting Your Plotter to a Computer

### What You'll Learn in This Chapter

This chapter explains how to connect your plotter to a computer so that you can use software packages or programs to create color graphics on your plotter.

The first part of this chapter contains a brief explanation of how your plotter communicates with a computer. The remainder of the chapter contains instructions on connecting specific computers to your plotter.

### An Introduction to Plotter/Computer Graphics

When your plotter is connected to a computer via an *interface cable*, the computer can be used to send “instructions” to the plotter. These instructions tell your plotter such things as which pens to select and where to draw lines on the paper. If the properly selected sequence of instructions is sent to the plotter, the result is a graphic picture — a pie chart, for example.

The plotter instructions, called *HP-GL instructions*, are normally sent to the plotter using a computer program. The program can be written in just about any programming language, such as BASIC, Pascal, or FORTRAN.

## Plotter/Computer Symptoms and Solutions

Use the following table if your plotter and computer work all right by themselves, but you can't get them to work as a team. Before using this table, be certain you have completed the interconnection instructions given for your computer in this chapter.

| Symptom   | Possible Cause  | Solution  |
|---|---|---|
| Test program won't run on the computer.                     | Test program entered wrong.                             | Program must be entered exactly as it appears in interconnect instruction. Double-check for errors.   |
|   | Program syntax wrong for computer.                      | Refer to your computer manual for correct BASIC syntax. Modify program as necessary.  |
|   | Program not entered or executed correctly.              | Refer to your computer manual for help running programs.  |
| Test program runs on computer, but plotter doesn't respond. | Interface cable not connected securely.                 | Check connectors.   |
|   | Wrong baud rate setting on plotter switches (RS-232-C). | Select proper setting (with plotter turned "off").  |
|   | Wrong address setting on plotter switches (HP-IB)       | Select proper setting (with plotter turned "off").  |
|   | Plotter turned off or paper not loaded.                 | Make certain plotter is turned on and paper is loaded.  |
|   | Wrong (or defective) interface cable.                   | Replace cable.  |
|   | Computer is not configured properly for plotter.        | Check configuration, especially baud rate (RS-232-C), address (HP-IB), and port used for interface. Refer to computer manual for additional help. |



## Apple IIe or II Plus Computer (RS-232-C Interface)

| Computer  | Cable     |
|---|-----------|
| Apple IIe or II Plus<br>Apple Super Serial Card<br>(Apple Part No. A2B0044) | HP 17355M |

### Interconnection Instructions

1. Install the Apple Super Serial Card as follows (refer to your computer documentation for details).
  - a. Set the two banks of switches on the serial card as shown here:

|     | 1   | 2   | 3   | 4  | 5   | 6   | 7   |
|-----|-----|-----|-----|----|-----|-----|-----|
| SW1 | Off | On  | Off | On | Off | On  | On  |
| SW2 | On  | Off | Off | On | Off | Off | Off |

- b. With your computer unplugged, install the serial card in slot #2 of the computer. Make sure that the arrow on the card's jumper block is pointing toward the word "TERMINAL."

- With your plotter and computer turned off, connect the plotter to the computer using the RS-232-C cable as shown below. Either end of the cable can be connected to the plotter or the connector on the installed serial card (port #2).

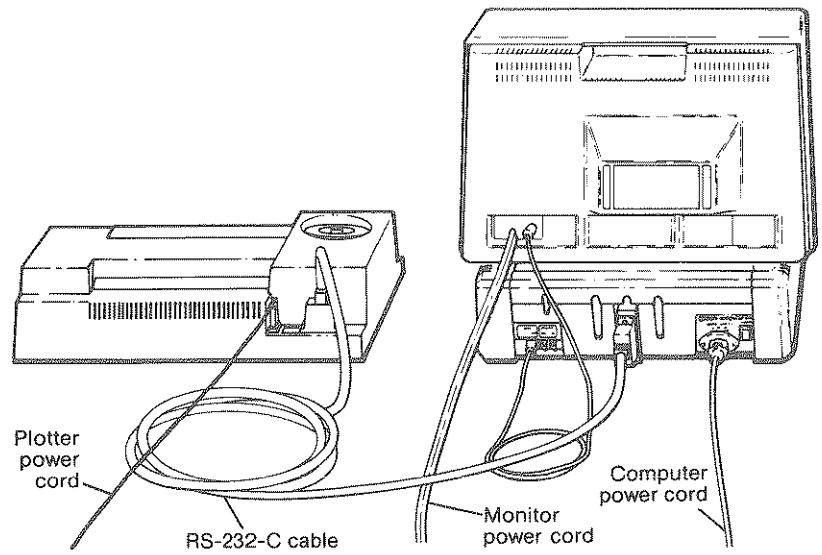

Computer Connections

- Set the switches on the rear panel of your plotter as shown in the following diagram. Your plotter checks the switch settings only when you turn it on, so be sure the plotter is turned off before changing switch settings.

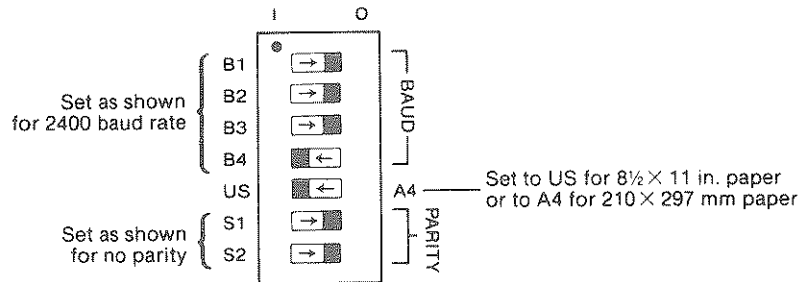

## Running the Test Program

To test the computer/plotter interface, turn on your computer and plotter, load pens and paper, and enter and run the following BASIC program. (If you need help entering and running the program, refer to your computer documentation.)

```
10 PR#2 : IN#2
20 PRINT CHR$(27) + ".M50;63;13;13:"
30 PRINT "IN;OI;"
40 INPUT ID$
50 PRINT "SP1;PA500,500;"
60 PRINT "LB";ID$;" COMMUNICATION OK";CHR$(3)
70 PRINT "PA0,0;SP0;"
80 PR#0 : IN#0
90 END
```

Your plotter will select pen #1 and print 7440A COMMUNICATION OK.

## Apple IIc Computer (RS-232-C Interface)

| Computer  | Cable   |
|-----------|---|
| Apple IIc | Apple Printer Cable<br>(Apple Part No. A9C0308) |

### Interconnection Instructions

1. With your plotter and computer turned off, connect the plotter to the computer using the Apple Printer Cable as shown below. The small, round end of the cable connects to Port 2 of the computer.

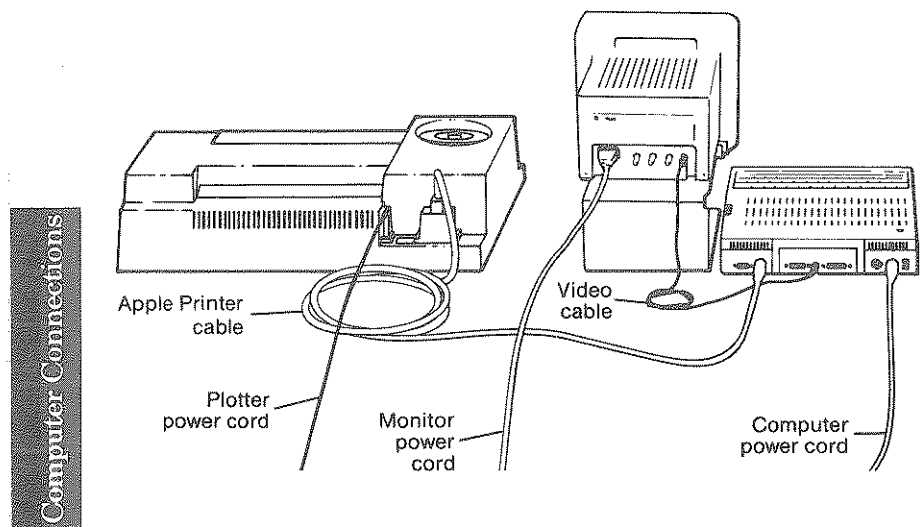

2. Set the switches on the rear panel of your plotter as shown in the following diagram. Your plotter checks the switch settings only when you turn it on, so be sure the plotter is turned off before changing switch settings.

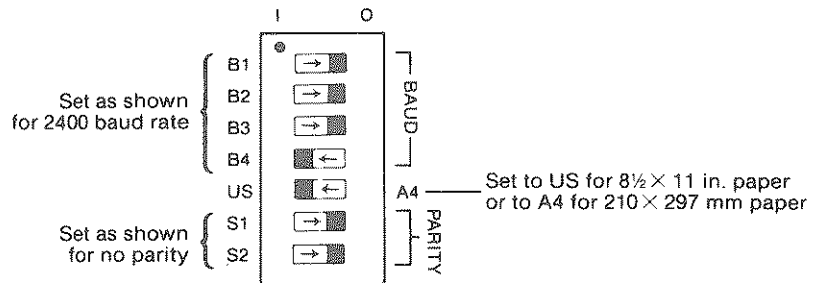

3. Configure your computer system as follows. (Refer to your computer documentation if you have difficulty with this step.) If you want to save the following configuration on disc, so you won't have to repeat the procedure every time you use your plotter with your computer, make a copy of the Systems Utilities disc first.
  - a. Load the System Utilities disc. From the main menu, press 8 on your keyboard to select ADVANCED OPERATIONS, then press RETURN.
  - b. Press 5 to select CONFIGURE THE SERIAL PORTS, then press RETURN.
  - c. Press 2 to select SET PORT 2, then press RETURN.
  - d. Press 8 to select I KNOW MY PIN, then press RETURN. When asked to enter the new PIN, type 254/1111 and press RETURN. When asked if the PIN is correct, answer YES if correct, and press RETURN.
  - e. When asked if you want to save the configuration, answer YES if you have made and are using a copy of the Systems Utilities disc. Press RETURN.

- f. Your screen should now display the new PIN number 254/1111 beneath SET PORT 2. Exit the System Utilities menu by pressing ESC twice, then press 9 and RETURN. When asked if you want to exit, select YES, and press RETURN.
- g. You should now be in BASIC and ready to enter and run the test program.

### Running the Test Program

To test the computer/plotter interface, turn on your computer and plotter, load pens and paper, and enter and run the following BASIC program. (If you need help entering and running the program, refer to your computer documentation.)

```
10 PRINT CHR$(4); "PR#2"  
20 PRINT CHR$(1); "10B"  
30 PRINT CHR$(4); "IN#2"  
40 PRINT CHR$(27) + ".MS0;63;13;13:"  
50 PRINT "IN;OI;"  
60 INPUT ID$  
70 PRINT "SP1;PA500,500:"  
80 PRINT "LB"+ID$+" COMMUNCIATION OK" + CHR$(3)  
90 PRINT "PA0,0;SP0;"  
100 PRINT CHR$(4); "PR#0"  
110 PRINT CHR$(4); "IN#0"  
120 END
```

Your plotter will select pen #1 and print 7440A COMMUNICA-TION OK.

## Apple III Computer (RS-232-C Interface)

| Computer       | Cable   |
|----------------|---|
| Apple III Unit | Apple III Modem Eliminator Cable (Apple Part No. A3M0019) and HP 17355M |

### Interconnection Instructions

1. With your plotter and computer turned off, connect the plotter to the computer using the RS-232-C and modem eliminator cables as shown below. Either end of the RS-232-C cable can be connected to the plotter.

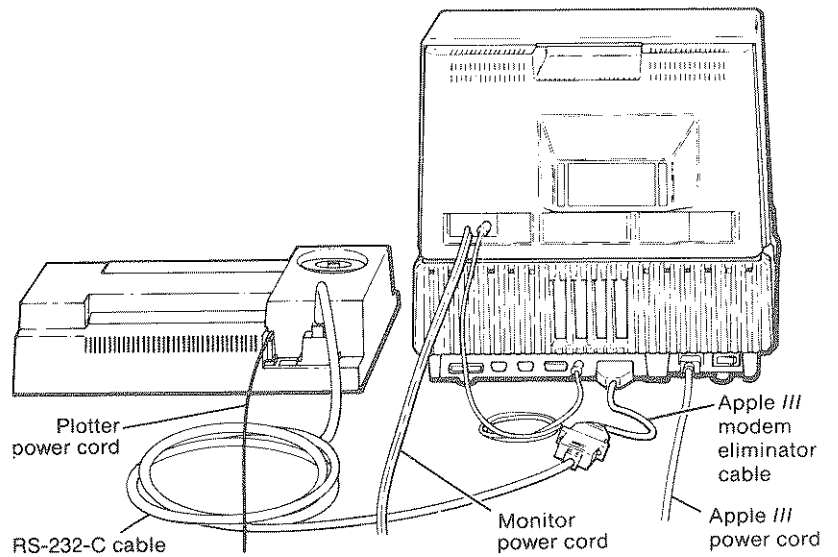

- Set the switches on the rear panel of your plotter as shown in the following diagram. Your plotter checks the switch settings only when you turn it on, so be sure the plotter is turned off before changing switch settings.

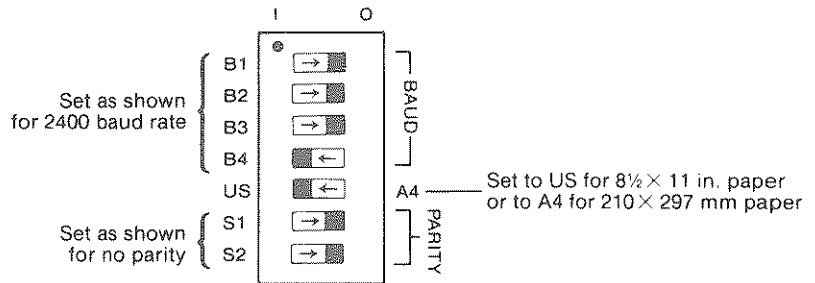

- Configure your computer system as follows. (Refer to your Apple III Standard Device Drivers Manual if you have difficulty with this step.) In order to run the test program, you will need to make a copy of your Apple Business BASIC disc that is not write protected.
  - Insert the System Utilities disc. Select the SYSTEM CONFIG. PROGRAM, then select READ A DRIVER FILE.
  - Load the System Utilities Data disc. Enter the pathname .D1/RS232.DRIVER and press the RETURN key. Reinsert the System Utilities disc, and press the ESCAPE key.
  - Select EDIT DRIVER PARAMETERS. Then select the number corresponding to .RS232 and press the RETURN key.
  - Select CONFIG BLOCK DATA, then enter the following values:

|              |    |    |    |    |    |    |    |    |    |    |    |    |
|--------------|----|----|----|----|----|----|----|----|----|----|----|----|
| <b>Byte</b>  | 0  | 1  | 2  | 3  | 4  | 5  | 6  | 7  | 8  | 9  | A  | B  |
| <b>Value</b> | 0A | 2E | 00 | 00 | 00 | 00 | 00 | 00 | 00 | 00 | 00 | 80 |

Press ESCAPE three times to return to the System Configuration Menu. Select READ A DRIVER FILE and read the other driver files by specifying the pathname .D1/SOS.DRIVER. Press ESCAPE to return to System Configuration Menu. Then select GENERATE NEW SYSTEM.



- e. Load the copy of the Apple Business BASIC disc and enter .D1/SOS.DRIVER as the new driver filename. This loads the new system configuration on the BASIC disc. Select DELETE to delete any old system configuration.

### Running the Test Program

To test the computer/plotter interface, turn on your computer and plotter, load pens and paper, and enter and run the following BASIC program. (If you need help entering and running the program, refer to your computer documentation.)

```
10 OPEN #1, ".RS232"  
20 PRINT #1; "IN;OI;"  
30 INPUT #1; ID$  
40 PRINT #1; "SP1;PA500,500;"  
50 PRINT #1; "LB"+ID$+" COMMUNICATION OK"+CHR$(3)  
60 PRINT #1; "PA0,0;SP0;"  
70 CLOSE #1  
80 END
```

Your plotter will select pen #1 and print 7440A COMMUNICATION OK.

## Apple Macintosh/Macintosh Plus/II/SE (RS-232-C Interface)

| Computer                 | Cable     |
|--------------------------|-----------|
| Apple Macintosh Computer | HP 92219M |
| Apple Macintosh Plus     | HP 17302A |
| Apple Macintosh II       | HP 17302A |
| Apple Macintosh SE       | HP 17302A |

### Interconnection Instructions

1. Turn off your plotter and computer equipment.
2. Set the switches on the rear panel of your plotter as shown in the following illustration. Your plotter checks the switch settings only when you turn it on, so be sure the plotter is turned off before changing the switch settings.

Computer Connections

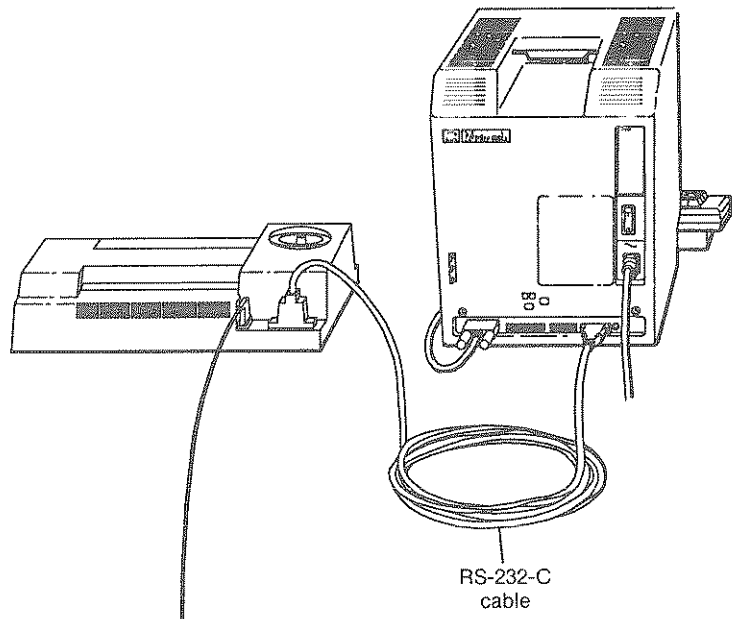

3. Connect the plotter to the computer. The following illustration shows an Apple Macintosh Computer. Be sure you use the correct cable for your computer.

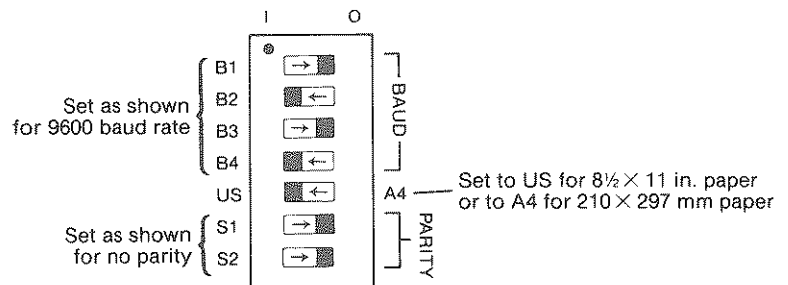

## Testing Communication with BASIC

Note that the verification program works only when the plotter is connected to the modem port. The program will not work when the plotter is connected to the printer port.

To test the computer/plotter interface, turn on your computer and plotter, load pens and paper, then enter and run the following BASIC (Macintosh BASIC 2.0 or higher) program. (If you need help entering and running the program, refer to your computer documentation.)

```

10 OPEN "COM1:9600,N,8,1,RS,CS65535,DS,CD" AS #1
20 PRINT #1, "IN;OI;"
30 INPUT #1, ID$
40 PRINT #1, "SP1;PA500,500;"
50 PRINT #1, "LB"+ID$+" PLOTTER OK"+CHR$(3)
60 PRINT #1, "PA0,0;SP0"
70 END

```

Your plotter selects pen #1 and prints 7440A PLOTTER OK.

## Commodore Amiga Personal Computers (RS-232-C Interface)

| Computer   | Cable                 |
|------------|-----------------------|
| Amiga 500  | HP 17255D             |
| Amiga 1000 | HP 17255M (or 13242G) |
| Amiga 2000 | HP 17255D             |

### Interconnection Instructions

1. With your equipment turned off, use the cable to connect the plotter to the computer's serial port. (The following illustration is of an Amiga 2000.)

Computer Connections

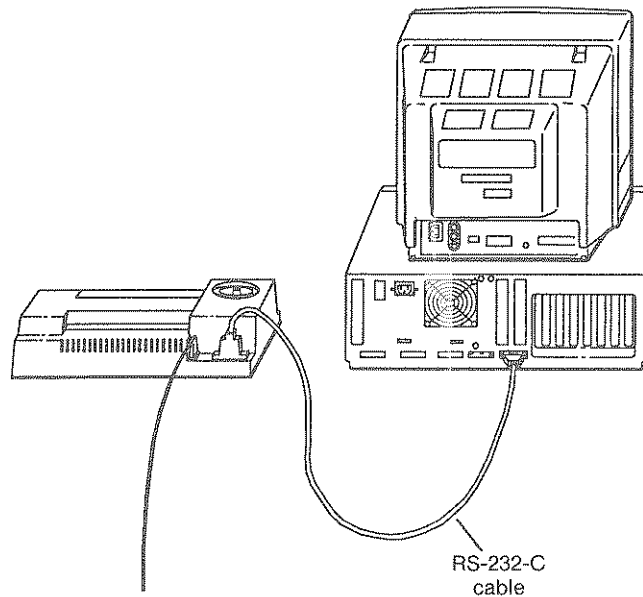

2. Set the switches on the rear panel of your plotter as shown in the following diagram. Your plotter checks the switch settings only when you turn it on, so be sure the plotter is turned off before changing the switch settings.

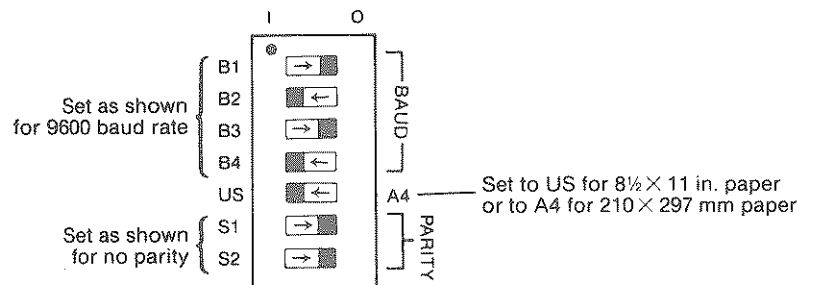

3. Turn on the printer, and boot up the Amiga using your working copy of the Workbench operation system.
4. Run the *Printer* utility in the Workbench Preferences drawer. Refer to Commodore's Workbench documentation for detailed instructions.
5. From the *Printer* main menu, select the *Serial* interface.
6. Save your settings and return to the Preferences drawer.
7. Set the Amiga's serial port settings as follows:
  - a. Double click on the *Serial* icon in the Preferences drawer.

- b. Select the following settings.

|                     |                                 |
|---------------------|---------------------------------|
| <b>Baud Rate:</b>   | 9600                            |
| <b>Read Bits:</b>   | 8                               |
| <b>Stop Bits:</b>   | 1                               |
| <b>Handshaking:</b> | RTS/CTS                         |
| <b>Buffer Size:</b> | 512 (may be adjusted as needed) |
| <b>Write Bits:</b>  | 8                               |
| <b>Parity:</b>      | None                            |

- c. Save your settings and return to the Workbench.

### Verifying Communication

To test the computer/plotter interface, turn on the plotter, load pens and paper, then follow these steps.

1. From Workbench, open the Utilities drawer, then double click on the *Notepad* icon.
2. Type the following HP-GL commands (uppercase only) into Notepad.

```
IN;SP1;PA0,0;PD0,1500,1500,1500,0,0;SP0
```

3. Select **Print as Draft**, then **Print** to send the commands to the plotter. The plotter will draw a triangle.

## DEC Professional 350 Computer (RS-232-C Interface)

| Computer | Cable  |
|----------|--|
| DEC 350  | DEC Printer Cable<br>(DEC Part No. BCC05) and<br>HP 17355F |

### Interconnection Instructions

1. With your plotter and computer turned off, connect the plotter to the computer using the RS-232-C cable and DEC printer cable as shown below.

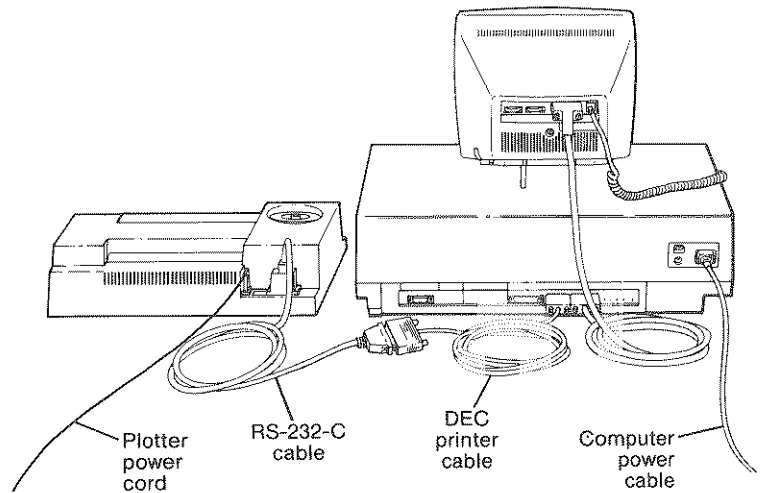

2. Set the switches on the rear panel of your plotter as shown in the following diagram. Your plotter checks the switch settings only when you turn it on, so be sure the plotter is turned off before changing switch settings.

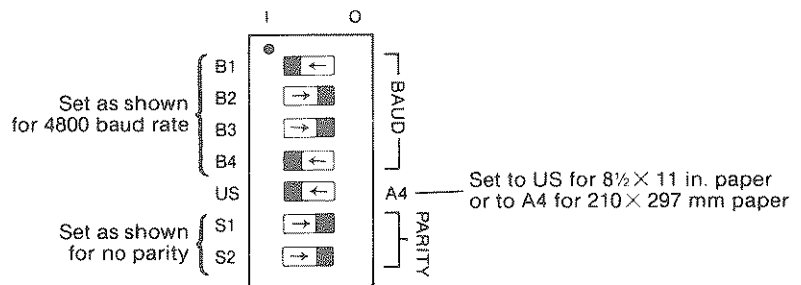

3. Configure your computer system as follows. (Refer to your computer documentation if you have difficulty with this step.)
  - a. Turn on the computer. From the main menu, select PRINT SERVICES and press the DO key. From the resulting menu, select SET PRINTER CHARACTERISTICS and press DO. The menu will change, then select PRINTER LOCATION.
  - b. From the printer destination menu, select LOCAL and press DO. From the printer type/location menu, select TYPE and press DO. Finally, select LVP16 and press DO.
  - c. Press the EXIT key twice to return to the main menu.



## Running the Test Program

To test the computer/plotter interface, turn on your computer and plotter, load pens and paper, and enter and run the following PRO/BASIC program. (If you need help entering and running the program, refer to your computer documentation.)

```
10 OPEN 'LP:' FOR OUTPUT AS FILE #1
20 OPEN 'LP:' FOR INPUT AS FILE #2
30 PRINT #1, CHR$(27)+"M0;0;13;13:"
40 PRINT #1, "IN;OI;"
50 INPUT #2, ID$
60 PRINT #1, "SP1;PA500,500;"
70 PRINT #1, "LB"+ID$+" COMMUNICATION OK"+CHR$(3)
80 PRINT #1, "PA0,0;SP0;"
90 CLOSE #1 \ CLOSE #2
100 END
```

Your plotter will select pen #1 and print 7440A COMMUNICATION OK.

## HP PORTABLE Computer (HP-IB Interface)

| Computer   | Cable                 |
|--|-----------------------|
| HP PORTABLE Computer<br>HP 9114A Disc Drive or equivalent*<br>HP 82169A<br>HP-IL/HP-IB Interface | HP 10833A, B, C, or D |

\*Required for running graphics software or programs.

### Interconnection Instructions

1. Set all the switches on the HP-IL/HP-IB Interface to zero.
2. With your plotter and computer turned off, connect your plotter to the computer using the HP-IL/HP-IB Interface and HP-IB cable as shown below:

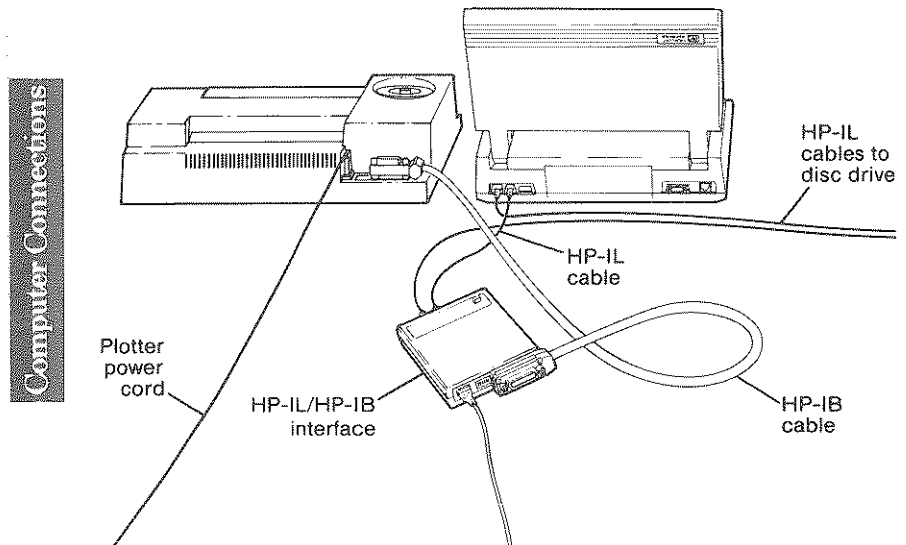

### Running the Test Program

To test the computer/plotter interface, turn on your computer and plotter, load pens and paper, and enter and run the following BASIC program. (If you need help entering and running the program, refer to your computer documentation.)

```
10 OPEN "O",1,"PLT"  
20 PRINT #1,"IN;SPI;PA500,500;"  
30 PRINT #1,"LBCOMMUNICATION OK"+CHR$(3)  
40 PRINT #1,"PA0;0;SP0;"  
50 END
```

Your plotter will select pen #1 and print COMMUNICATION OK.

2. Set the switches on the rear panel of your plotter as shown in the following diagram. Your plotter checks the switch settings only when you turn it on, so be sure the plotter is turned off before changing switch settings.

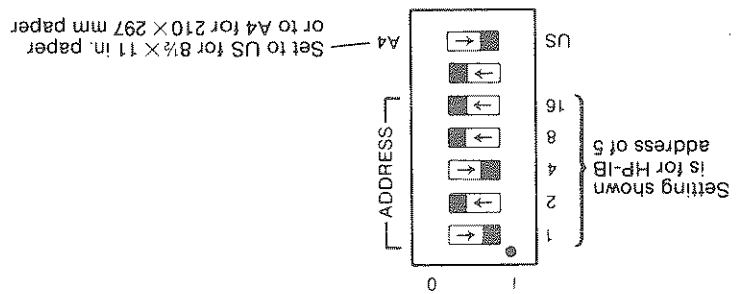

3. Configure your computer system as follows. (Refer to your computer documentation if you have difficulty with this step.)
  - a. Load the MS-DOS System Disc. Touch DEVICE CONFIG. Then touch START APPLIC to display the device configuration screen.
  - b. Touch the PLT field, then use the NEXT CHOICE key to select PLT: HP-IB 5. Touch SAVE CONFIG to save the configuration.
  - c. Press the EXIT CONFIG key to return to P.A.M.

Computer Connections

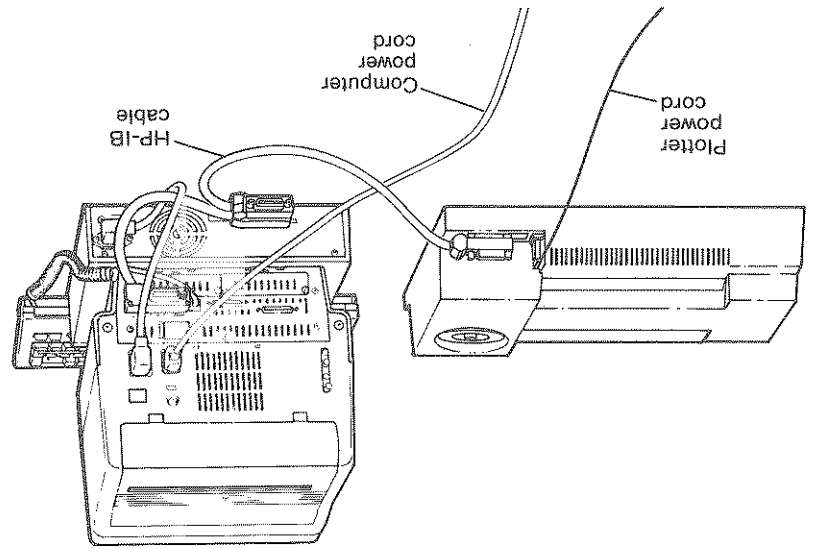

With your plotter and computer turned off, connect the plotter to the computer using the HP-IB cable as shown below. Either end of the cable can be connected to the plotter or computer.

Interconnection Instructions

|          |   |
|----------|---|
| Computer | HP Touchscreen or Touchscreen MAX Personal Computer (or HP 150 System with Dual Disc Drive) |
| Cable    | HP 10833A, B, C, or D   |

HP Touchscreen Personal Computer (HP 150) (HP-IB Interface)

2. Set the switches on the rear panel of your plotter as shown in the following diagram. Your plotter checks the switch settings only when you turn it on, so be sure the plotter is turned off before changing switch settings.

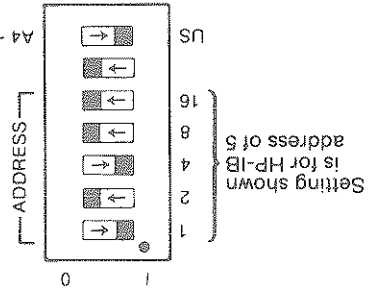

### Running the Test Program

To test the computer/plotter interface, turn on your computer and plotter, load pens and paper, and run the following BASIC program. (If you need help entering and running the program, refer to your computer documentation.)

```

10 OUTPUT 705 : "IN:01:"
20 ENTER 705 : ID$
30 OUTPUT 705 : "SP1:PA500,500:"
40 OUTPUT 705 : "LB" & ID$ & " COMMUNICATION OK" & CHR$(3)
50 OUTPUT 705 : "PA0,0:SP0:"
60 END

```

Your plotter will select pen #1 and print 7440A COMMUNICATION OK.

## HP Series 200 Personal Technical Computer (HP-IB Interface)

|          |                                    |
|----------|------------------------------------|
| Computer | HP Model 216, 226, or 236 Computer |
| Cable    | HP 10833A, B, C, or D              |

### Interconnection Instructions

1. With your plotter and computer turned off, connect the plotter to the computer using the HP-IB cable shown. Either end of the cable can be connected to the plotter or computer. The illustration below shows an HP Model 216 connected to the plotter.

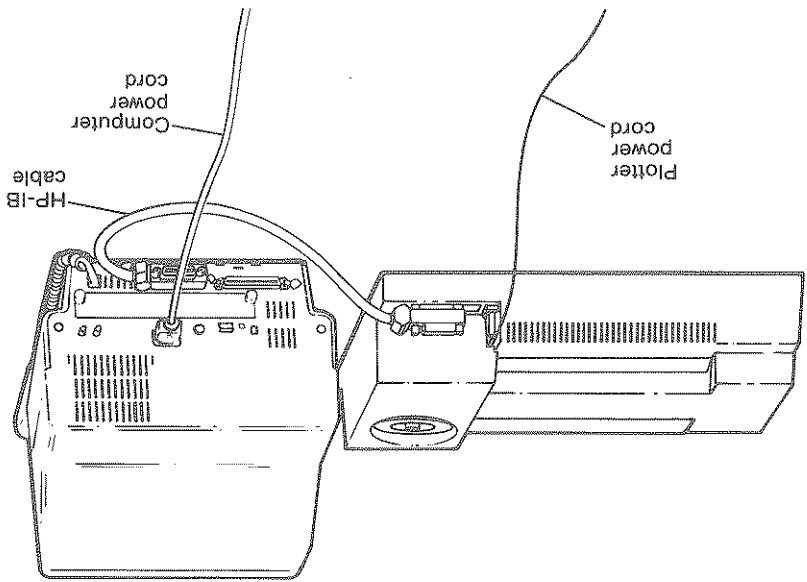

## Running the Test Program

To test the computer/plotter interface, turn on your computer and plotter, load pens and paper, and enter and run the following BASIC program. (If you need help entering and running the program, refer to your computer documentation.) If you do not own a BASIC disc, refer to the following section.

```
10 OPEN "0",1,"PLT"  
20 PRINT #1, "IN:SP1;PA500,500:"  
30 PRINT #1, "LBCOMMUNICATION OK"+CHR$(3)  
40 PRINT #1, "PA0,0:SP0:"  
50 END
```

Your plotter will select pen #1 and print COMMUNICATION OK.

## Interface Test Using MemoMaker

If you have no BASIC disc for The PORTABLE, you can test the interface using the built-in MemoMaker application program as follows:

1. Turn on your computer and plotter, and load pens and paper.
2. Use MemoMaker to create the following one-line memo. (Refer to your computer documentation if you have trouble.)

```
IN:SP1;PA2000,1500;PD0,1500,2000,3500,2000,1500,1500;SP0;
```

3. Use the FILE and SAVE MEMO function keys to send the memo to the plotter by using the file name PLT.

Your plotter will select pen #1 and draw a triangle.



2. Set the switches on the rear panel of your plotter as shown in the following diagram. Your plotter checks the switch settings only when you turn it on, so be sure the plotter is turned off before changing switch settings.

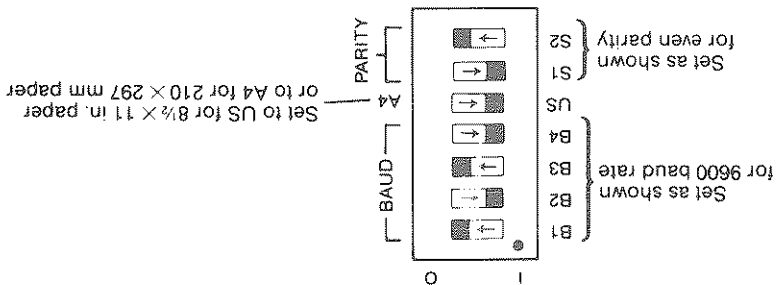

3. Configure **THE PORTABLE** as follows. (Refer to your computer documentation if you have difficulty with this step.)

- a. Turn on the computer and select **SYSTEM CONFIG**. Use the cursor keys to move the cursor to **PLOTTER INTERFACE**.
- b. Press **NEXT CHOICE** to select **SERIAL**. If you are using a disc drive, check the **EXTERNAL DISC DRIVES** selection and make sure it is set to the appropriate number.

c. Press **EXIT CONFIG** to save the configuration data. Then press **DATACOM CONFIG** to access the data communications menu.

d. Press **DEFAULT VALUES**. Use the [F3] and [F4] keys and the cursor keys to change the serial interface selection as follows.

SERIAL PORT: RS-232  
 SERIAL BAUD RATE: 9600  
 SERIAL XON/XOFF PACING: OFF  
 SERIAL DSR LINE: OBSERVE

e. Press **EXIT CONFIG** to save the configuration data.

# HP PORTABLE Computer (RS-232-C Interface)

|          |  |
|----------|--|
| Computer | HP PORTABLE Computer<br>HP 9114A Disc Drive or equivalent* |
| Cable    | HP Serial Printer Cable<br>(HP Part No. 92221P)            |

\*Required for running graphics software or programs.

## Interconnection Instructions

1. With your plotter and computer turned off, connect the plotter to the computer's serial port using the serial printer cable as shown below.

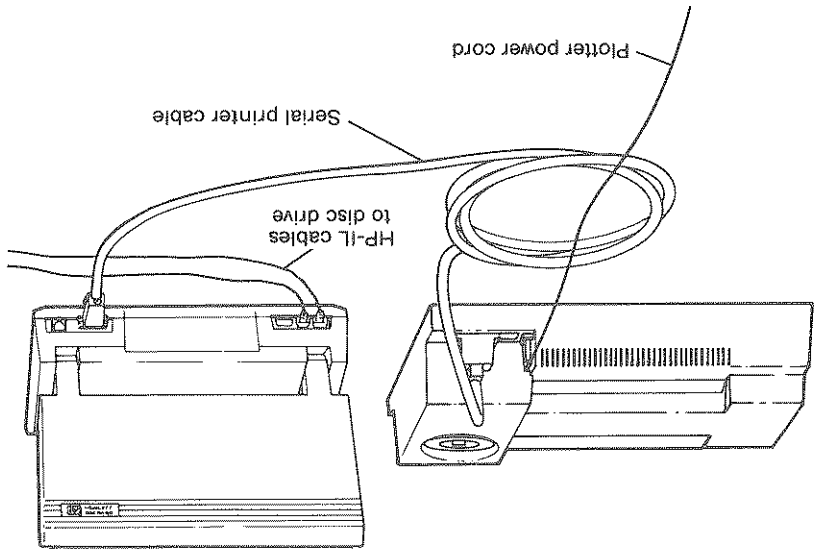

## Computer Connections

Your plotter will select pen #1 and draw a triangle.  
 2. Use the FILE and SAVE MEMO keys to send the memo to the plotter by using the filename PLT.

```
IN:SP1;PA2000,1500;PD0,1500,2000,3500,2000,1500;SP0;
```

1. Use MemoMaker to create this one-line memo:  
 If you don't own a BASIC disc for The PORTABLE, you can test the interconnection using the built-in MemoMaker application program. Turn on your computer and plotter, load pens and paper, and perform the following steps:

**Using MemoMaker to Test the Connection**

OK.  
 Your plotter will select pen #1 and print COMMUNICATION

```
10 OPEN "0",1,"PLT"  

20 PRINT #1,"IN:SP1;PA500,500;"  

30 PRINT #1,"LBCOMMUNICATION OK"+CHR$(3)  

40 PRINT #1,"PA0,0;SP0;"  

50 END
```

To test the computer/plotter interface, turn on your computer and plotter, load pens and paper, and enter and run the following BASIC program. (If you need help entering and running the program, refer to your computer documentation.) If you do not own a BASIC disc, refer to the following section.

**Running the Test Program**

**Computer Connections**

4. Configure The PORTABLE as follows:
  - a. Turn on the computer and select SYSTEM CONFIG. Use the cursor keys to move the cursor to PLOTTER INTERFACE.
  - b. Change the PLOTTER INTERFACE selection to HP-IB:05. Check the EXTERNAL DISC DRIVES selection and make sure it is set to the number of disc drives you're using.
  - c. Press EXIT CONFIG to save the new plotter configuration.

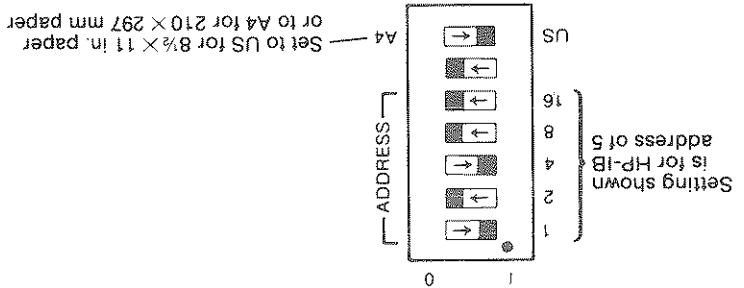

3. Set the switches on the rear panel of your plotter as shown by the following diagram. Your plotter checks the switch settings only when it is turned on, so be sure the plotter is turned off before changing switch settings.

## HP Touchscreen Personal Computer (HP 150) (RS-232-C Interface)

| Computer  | Cable                  |
|---|------------------------|
| HP Touchscreen or Touchscreen MAX Personal Computer (or HP 150 System with Dual Disc Drive) | HP 17255M or HP 13242G |

### Interconnection Instructions

1. With your plotter and computer turned off, connect the plotter to port 2 of the computer using the RS-232-C cable as shown below. Either end of the cable can be connected to the plotter or computer.

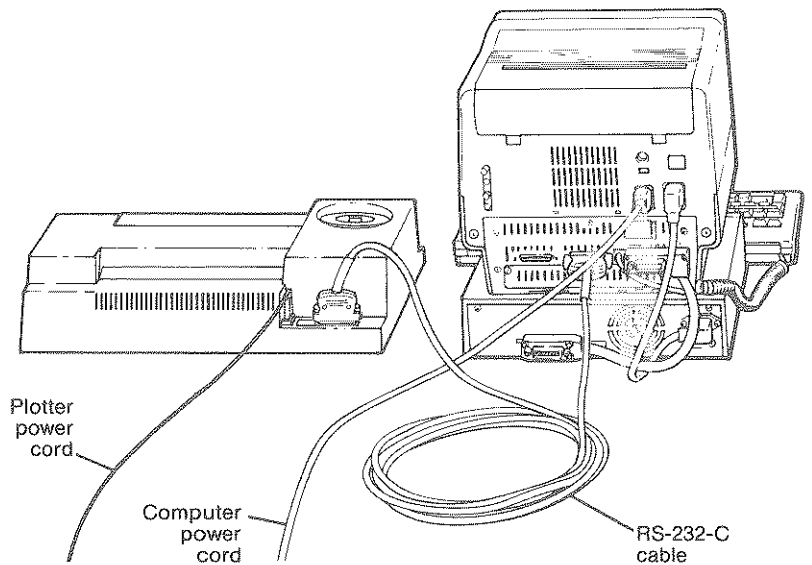

2. Set the switches on the rear panel of your plotter as shown in the following diagram. Your plotter checks the switch settings only when you turn it on, so be sure the plotter is turned off before changing switch settings.

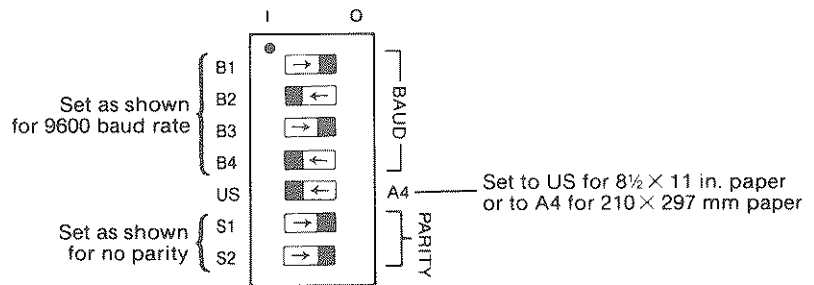

3. Configure your computer system as follows. (Refer to your computer documentation if you have difficulty with this step.)
  - a. Load the MS-DOS System Disc. Touch DEVICE CONFIG. Then touch START APPLIC to display the DEVICE CONFIGURATION screen.
  - b. Touch the PLT field, then use the NEXT CHOICE key to select PLT: PORT 2. Next, touch SAVE CONFIG.
  - c. Press the USER/SYSTEM key on your keyboard twice to change the function key selections. Then select CONFIG KEYS.
  - d. Select the PORT 2 CONFIG field to display the PORT 2 screen. Press the SYSTEM DEFAULTS key, then the DEFAULT VALUES key. Use the NEXT CHOICE key to select BAUD RATE 9600. Then use the cursor controls to select the CS(CB)XMIT field. Use the NEXT CHOICE key to set the field to YES.
  - e. Touch SAVE CONFIG to save the new configuration. Hold down the SHIFT key and press the USER/SYSTEM key. Press the EXIT CONFIG to return to P.A.M.

## Running the Test Program

To test the computer/plotter interface, turn on your computer and plotter, load pens and paper, and enter and run the following BASIC program. (If you need help entering and running the program, refer to your computer documentation.)

```
10 OPEN "0",1,"PLT"  
20 PRINT #1, "IN;OI;"  
30 CLOSE #1  
40 OPEN "1",2,"PLT"  
50 INPUT #2, ID$  
60 OPEN "0",1,"PLT"  
70 PRINT #1, "SP1;PA500,500;"  
80 PRINT #1, "LB";ID$;" COMMUNICATION OK"+CHR$(3)  
90 PRINT #1, "PA0,0;SP0;"  
100 END
```

Your plotter will select pen #1 and print 7440A COMMUNICATION OK.

## Personal Computers (Compatibles using RS-232-C Interface)

These instructions tell you how to connect your plotter to the following compatible computers.

AT&T PC 6300  
COMPAQ DESKPRO 286 and 386/20  
HP Vectra, ES/12, QS/16, and RS/20  
IBM AT, PC, PC/XT, and PS/2

| Computer  | Cable                     |
|---|---------------------------|
| AT&T PC 6300, COMPAQ 286 and 386,<br>IBM AT, PC, PC/XT, PS/2<br>with standard serial interface<br>using a 25-pin male connector | HP 17255D                 |
| with asynchronous communication adapter<br>using a 9-pin male connector   | HP 24542G                 |
| HP Vectra, ES/12, QS/16, RS/20<br>with HP 24540A or HP 24541A card<br>using 9-pin male connector                                | HP 24542G                 |
| with the HP 24541A dual serial card<br>using 25-pin female connector  | HP 17255M<br>or HP 13242G |

### Interconnection Instructions

1. Turn off your plotter and computer equipment.
2. If necessary, install the serial interface card. (Refer to your computer documentation for details.) If you have already installed a serial card, go to step 3.

**NOTE:** If you have more than one serial port installed, you will need to know whether you're connecting the plotter to COM1 or COM2 (most software will not run on COM3). You will need this information for testing communications and for configuring your software. If you are using COM2, be sure to substitute COM2 for COM1 in the instructions. ■



- Set the switches on the rear panel of your plotter as shown in the following illustration. Your plotter checks the switch settings only when you turn it on, so be sure the plotter is turned off before changing the switch settings.

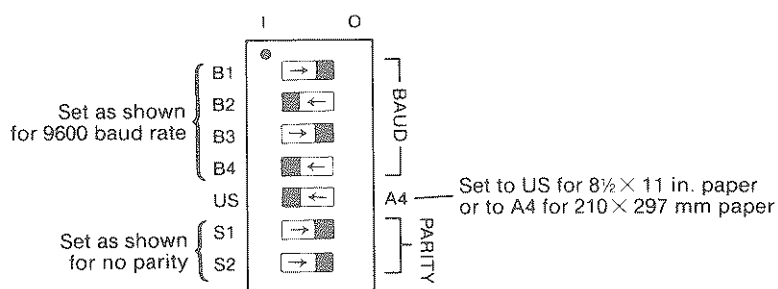

- Connect the plotter to the computer. The following illustration shows an HP Vectra PC.

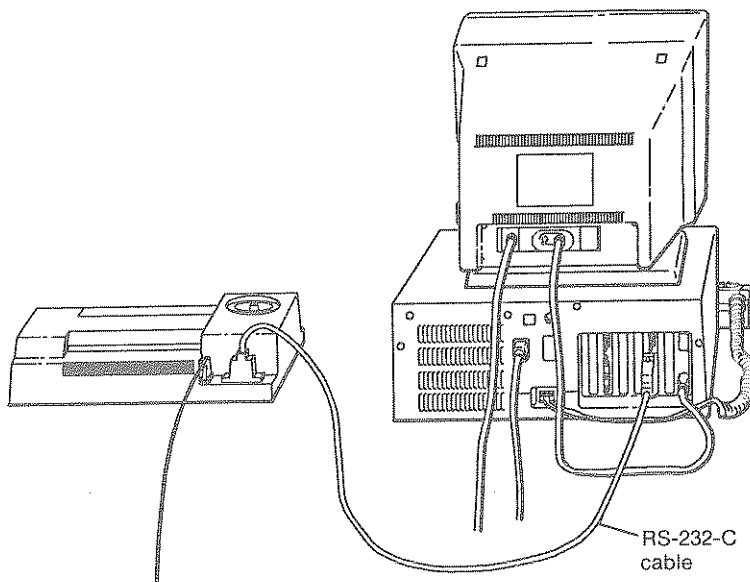

Be sure you are using the correct cable for your computer and plotter.

## Running the Test Program

To test the computer/plotter interface, turn on your computer and plotter, load pens and paper, then follow these steps.

1. At the DOS prompt, type the following (substitute COM2 for COM1, if necessary) and press ENTER.

```
MODE COM1:9600,N,8,1,P
```

This sets the RS-232-C port for 9600 baud, no parity, 8 data bits, one stop bit, and continuous error checking.

2. Enter and run the following BASIC program (substitute COM2 for COM1, if necessary). (If you need help entering and running the program, refer to your computer documentation.)

```
10 OPEN "COM1:9600,N,8,1,RS,CS65535,DS,CD" AS #1
20 PRINT #1, "IN;OI;"
30 INPUT #1, ID$
40 PRINT #1, "SP1;PA500,500;"
50 PRINT #1, "LB"+ID$+" PLOTTER OK"+CHR$(3)
60 PRINT #1, "PA0,0;SP0;"
70 END
```

Your plotter selects pen #1 and prints 7440A PLOTTER OK.

## Olivetti M24 Computer (RS-232-C Interface)

| Computer                 | Cable     |
|--------------------------|-----------|
| Olivetti M24 System Unit | HP 17255D |

### Interconnection Instructions

1. With your plotter and computer turned off, connect the plotter to the computer using the RS-232-C cable as shown below. Note that the female end of the cable connects to the port labeled SERIAL on the computer.

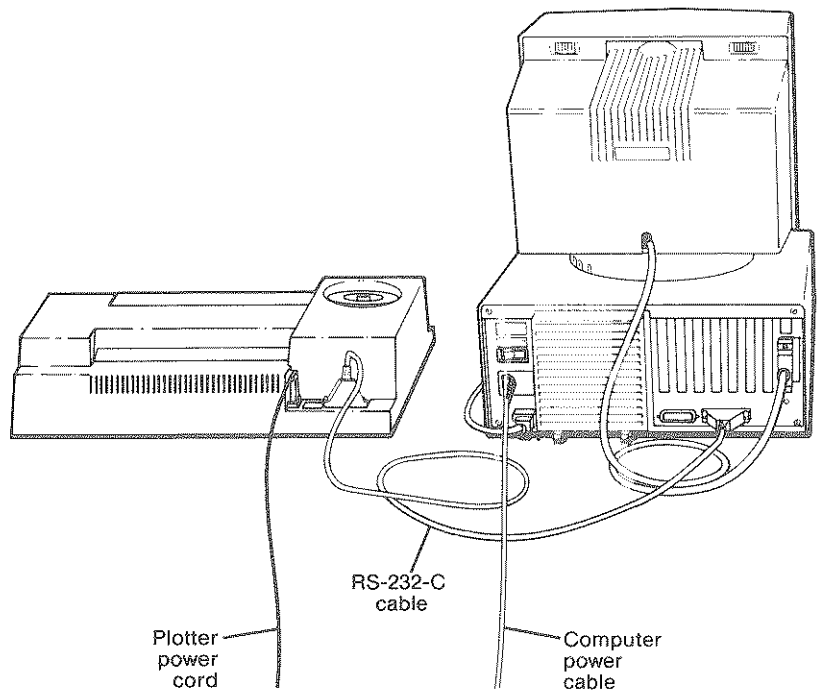

- Set the switches on the rear panel of your plotter as shown in the following diagram. Your plotter checks the switch settings only when you turn it on, so be sure the plotter is turned off before changing switch settings.

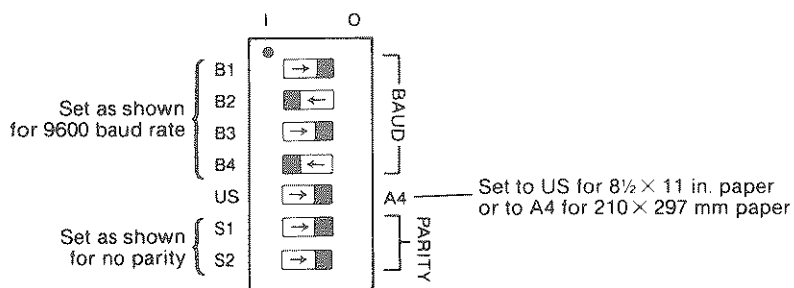

### Running the Test Program

To test the computer/plotter interface, turn on your plotter and load pens and paper. Turn on your computer, load the operating system disc, load BASIC, and then enter and run the following BASIC program. (If you need help entering and running the program, refer to your computer documentation.)

```

10 OPEN "COM1:9600,S,7,1,RS,CS65535,DS,CD" AS #1
20 PRINT #1, "IN:OI;"
30 INPUT #1, ID$
40 PRINT #1, "SP1;PA500,500;"
50 PRINT #1, "LB"+ID$+" COMMUNICATION OK"+CHR$(3)
60 PRINT #1, "PA0,0;SP0;"
70 END

```

Your plotter will select pen #1 and print 7440A COMMUNICATION OK.

Computer Connections

# Sirius 1 Computer (RS-232-C Interface)

| Computer             | Cable     |
|----------------------|-----------|
| Sirius 1 System Unit | HP 13242G |

### Interconnection Instructions

1. With your plotter and computer turned off, connect the plotter to the computer using the RS-232-C cable as shown below. Note that one end of the cable connects to serial port A of the computer.

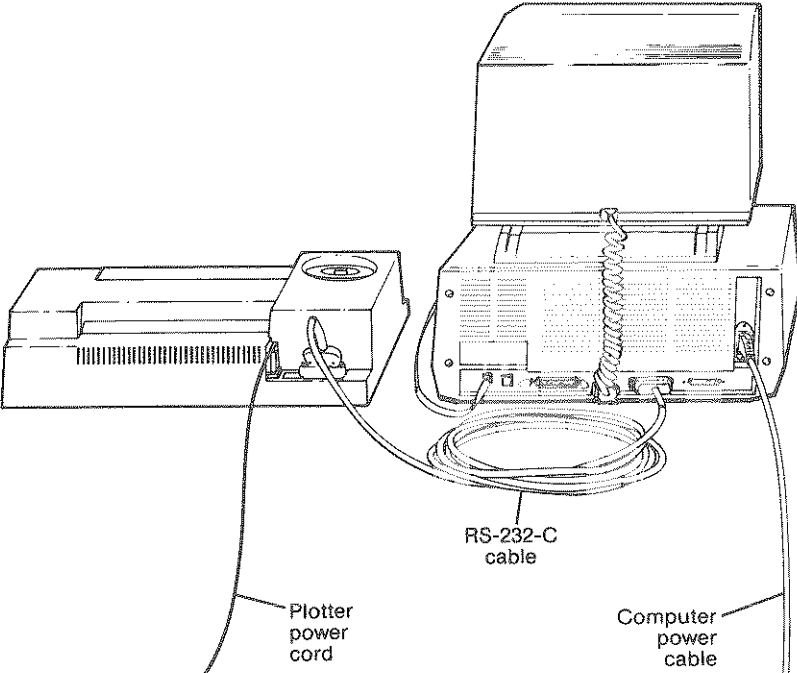

Computer Connections

2. Set the switches on the rear panel of your plotter as shown in the following diagram. Your plotter checks the switch settings only when you turn it on, so be sure the plotter is turned off before changing switch settings.

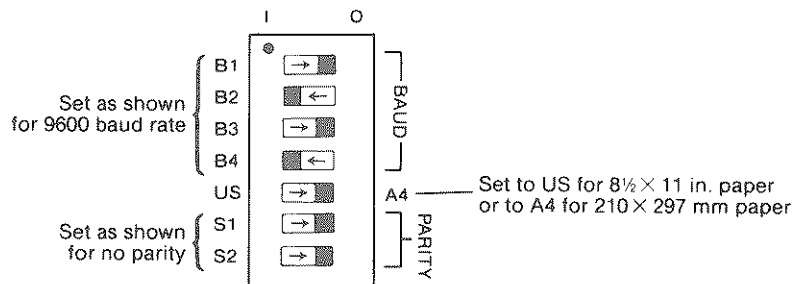

3. Configure your computer system as follows. (Refer to your computer documentation if you have difficulty with this step.)
  - a. Load the operating system disc, then type and enter SETIO AUXOUT=TTY to select port A.
  - b. Type and enter PORTSET to obtain the configuration menu, then type and enter 1 to obtain the port A setup information. Type and enter N to select 9600 baudrate and exit the configuration menu.

### Running the Test Program

To test the computer/plotter interface, turn on your plotter, load pens and paper, and enter and run the following BASIC program. (If you need help entering and running the program, refer to your computer documentation.)

```

10 OPEN "O", #1, "AUX"
20 PRINT #1, "IN; SP1; PA500, 500; "
30 PRINT #1, "LB COMMUNICATION OK"; CHR$(3)
40 PRINT #1, "PA0, 0; SP0; "
50 END
  
```

Your plotter will select pen #1 and print COMMUNICATION OK.

## Notes

---

---

CHAPTER

4



## Creating Graphics on Your Plotter

### What You'll Learn in This Chapter

This chapter provides important information on using graphics software packages or programs to create color graphics on your plotter. Be sure to read it before attempting to run your graphics software package.

### Using Graphics Software Packages

You can either buy graphics computer programs (software packages), or you can write your own. If you plan to use a software package with your plotter, there are a few things you should know before reading your software documentation and trying your software.

In Chapter 3 you learned how to configure your computer and set the switches on your plotter so that the computer could send instructions to the plotter using a test program. You may not need to do anything else to use your software package with your plotter, although some software packages may require some simple, additional procedures.

Some graphics packages, for example, will ask you to configure the software — this is usually done by typing or selecting answers on your computer in response to questions asked by the software. A software package might ask you what type of plotter you are using, or to which port on your computer you have connected

the plotter. If your software asks you configuration questions, answer them carefully to avoid communication problems.

**NOTE:** Your software documentation may recommend plotter switch settings that are different from the ones shown for your equipment in Chapter 3. If your software documentation recommends specific plotter switch settings, use the recommended settings. Remember to turn your plotter off before changing switch settings. ■

#### For RS-232-C Interface Users . . .

When using an RS-232-C interface, the computer sends information to the plotter at a certain rate, called the *baud rate*. You tell the computer (or computer software) what baud rate to use when you configure it, and you tell the plotter what baud rate to use when you set the baud rate switches, which are labeled **BAUD** on the plotter's rear panel.

For an RS-232-C plotter interface, the baud rate switch setting on the rear panel must match the baud rate used by the graphics software package. To determine what baud rate your software package uses, refer to your software documentation (try checking under "baud rate" or "configuring" in the documentation's index). Then, set the baud rate switches on the plotter's rear panel to match the software baud rate as shown by the following figure. (The examples shown set the plotter to accept and send one stop bit. Refer to Appendix C for more information or additional baud rate settings.)

If your software doesn't require any configuring or if no plotter baud rate settings are suggested in your software documentation, leave the baud rate switches as you set them in Chapter 3. If your software offers several different baud rate selections, you should select the fastest (largest) baud rate setting that will work with your computer and plotter —try using the baud rate setting recommended for your computer in Chapter 3.

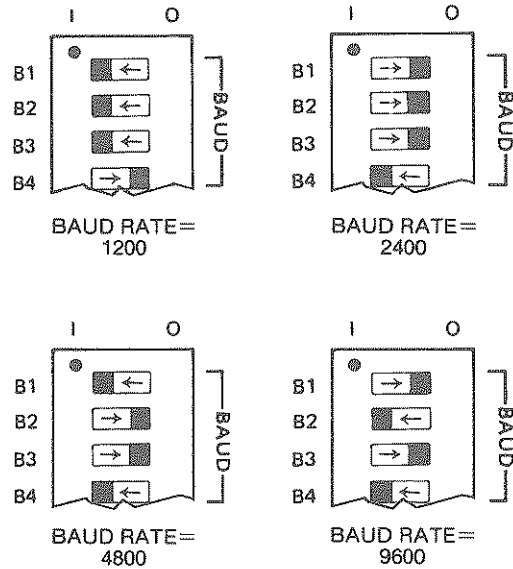

*Plotter Baud Rate Settings (Examples)*

**For HP-IB Users . . .**

If you are using a plotter that has an HP-IB interface, the address switch setting on the rear panel must match the HP-IB address used by the graphics software package. If your software requires configuring, select an HP-IB address of 5 and be certain your plotter's address switches are set as shown by the following figure. If you need to use an address other than 5, refer to Appendix B for a complete listing of address switch settings.

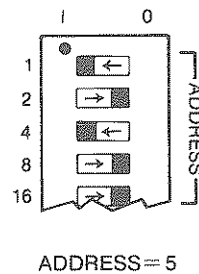

ADDRESS = 5

*Plotter HP-IB Address Setting (Example)*

## Writing Your Own Graphics Programs

If you would like to write your own graphics programs using the HP-GL programming language, an extensive programming document — the HP ColorPro Programming Manual — is available from Hewlett-Packard. Refer to Appendix D for ordering information and details on the manual's contents.

Although most graphics software packages allow you to specify the labels you need for your graphs, there may be occasions when you would like to add additional labels or graphics — a company logo, for example. The HP ColorPro Programming Manual explains how this can be accomplished by writing your own graphics programs that will add labels or graphics to software-generated graphs.

## Plotter/Software Symptoms and Solutions

Use the following table if you have successfully run the test program in Chapter 3, but are having trouble using a graphics software package with your computer and plotter.

| Symptom   | Possible Cause   | Solution  |
|---|--|---|
| Software will not run on computer.                                  | Software not loaded correctly.   | Refer to computer and software manual.  |
|   | Wrong software for computer.   | Check with software supplier.   |
| Software runs on computer, but plotter doesn't respond to software. | Software or computer not configured correctly for system.                                | Check configuration, refer to your software documentation for additional help.  |
|   | Baud rate switch setting on plotter doesn't match baud rate used by software (RS-232-C). | Refer to software manual for correct baud rate. Select correct rate on plotter switches (with plotter turned "off").  |
|   | Plotter address setting doesn't match address used by software (HP-IB).                  | Refer to software manual for correct address. Select correct address on plotter switches (with plotter turned "off"). |

CHAPTER

5



## Selecting Plotter Paper and Pens

### What You'll Learn in This Chapter

This chapter shows you how to select and use the various types of pens and paper available for your plotter. The table in the *Paper and Pen Combinations* section below gives you a quick summary of the best combinations. The rest of the chapter describes each paper and pen type in more detail.

### Paper and Pen Combinations

Your plotter can use three types of paper and two types of pens. For a given application, we suggest using the correct combination of paper and pen, and pen plotting speed. The following table shows the three paper types available, typical applications, and the pens and plotting speeds that work best with them.

| Paper Type                | Applications          | Pen Type              | Pen Speed*          |
|---------------------------|-----------------------|-----------------------|---------------------|
| Plotter paper             | Everyday use          | Paper                 | Normal<br>(50 cm/s) |
| Glossy presentation paper | Special presentations | Paper<br>Transparency | Slow<br>(10 cm/s)   |
| Transparency film         | Overhead projections  | Transparency          | Slow<br>(10 cm/s)   |

\*See the *Pen Speed* section in this chapter for information on changing plotter pen speed.

## Pen Speed

Your plotter is designed to plot at a predetermined speed (40 cm/s) suitable for creating plots on standard plotter paper using paper pens. For best quality when using transparency pens with glossy presentation paper or transparency film, however, we recommend that you use a slow pen speed (10 cm/s).

If you are using a graphics software package, it may allow you to specify whether you want to plot on paper or transparency film. If so, select “transparency” (slow pen speed) when using transparency pens to obtain optimum plot quality.

If you are programming your plotter, use the *VS HP-GL* instruction to change the pen speed to 10 cm/s when you intend to use transparency pens.



## Paper/Pen Symptoms and Solutions

Use the following table if you are having a problem that seems related to the plotter paper or pens.

| Symptom                             | Possible Cause   | Solution   |
|-------------------------------------|--|--|
| A pen does not write.               | The pen tip is dry.  | Revive the pen by writing manually with it.                                      |
|                                     | There is lint on the pen tip.                                      | Remove lint.   |
|                                     | The pen is out of ink or defective.                                | Replace the pen.   |
| The pens dry out before being used. | Rubber pen boots on carousel are loose, damaged, or missing.       | Refit or replace pen boots.  |
|                                     | Pens were stored past their shelf life.                            | Use pens before expiration date on package.                                      |
| Pens skip or drag.                  | Oil on paper.  | Insert new paper; handle paper by edges only.                                    |
|                                     | The plotter needs adjusting.                                       | See <i>Returning Your Plotter for Service</i> in Chapter 6.                      |
| Pen tips wear out quickly.          | The paper surface is too coarse.                                   | Use recommended paper only.  |
| Pen line width is too wide.         | Pen tip is worn.   | Insert new pen.  |
|                                     | The paper surface is too coarse.                                   | Use recommended paper only.  |
| Ink smears or doesn't dry.          | Pen and paper are not compatible; transparency pen speed too fast. | Use recommended paper/pen combination; use slow pen speed for transparency pens. |

(Table continues)

| Symptom                                | Possible Cause                                     | Solution                                 |
|--|--|--|
| Ink "bleeds" on regular plotter paper. | Paper is too coarse or absorbent.                  | Use recommended paper only.              |
|  | Transparency pens are being used.                  | Use paper pens.                          |
| Plots "drift" or are misregistered.    | The paper has been moved or prevented from moving. | Keep the plotter and paper unobstructed. |
|  | The pinch wheels are covered with lint or dirt.    | Clean the wheels with compressed air.    |

## Notes

---

CHAPTER

6

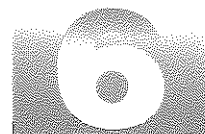

## Plotter Maintenance

### What You'll Learn in This Chapter

This chapter tells you how to care for your plotter. Information is also included on returning your plotter if it needs servicing.

### Plotter Maintenance

Maintenance of your plotter is limited to a periodic cleaning. Cleaning intervals will depend upon environmental conditions and how much you use your plotter. All maintenance other than cleaning must be performed by qualified service personnel.

If you suspect your plotter needs servicing, refer to *Returning Your Plotter for Service* in this chapter.

### Cleaning the Plotter

---

**WARNING**

Unplug your plotter's power supply from the ac power outlet before cleaning. Do not allow water to run inside the plotter, as this may create a shock hazard.

---

Clean the outer surface of your plotter as follows:

1. Blow away lint and dust accumulation (with compressed air if available), being sure to get rid of any accumulation on paper-drive wheels.
2. Clean the outer plastic surface of the plotter with a damp sponge or lint-free cloth. We recommend using a solution of half water and half denatured or isopropyl alcohol. Wipe off any residue with a sponge or cloth dampened with water only, and dry with a soft, lint-free cloth.

---

#### CAUTION

Do not use abrasive cleaners, cleaning solvents, or strong detergents to clean your plotter, as they may damage the plastic surfaces. In addition, keep water and other liquids off the paper drive wheels.

---

### Cleaning the Pen Carousel

Clean the pen carousel periodically to remove ink, lint, or dust. Wipe the holes in the carousel's rubber pen boots with a cotton swab moistened with denatured isopropyl alcohol or transparency ink solvent (Part No. 5060-6828). Let the carousel dry thoroughly before inserting pens.

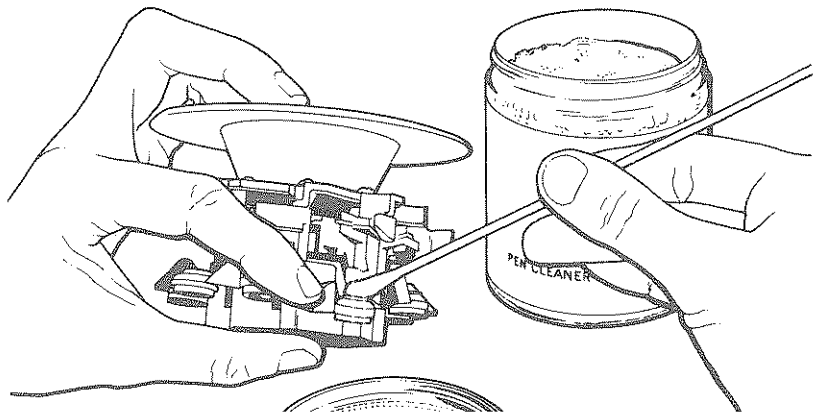

## Determining If Your Plotter Needs Service

Your plotter is designed to give you years of reliable service. If you are having a problem with your plotter, however, use the appropriate *Symptoms and Solutions* table in this manual to help determine if your plotter needs servicing.

Four *Symptoms and Solution* tables are included:

*Plotter Symptoms and Solutions (Chapter 1)* — Refer to this table if you are having trouble getting your plotter to turn on or respond to the front-panel controls.

*Plotter/Computer Symptoms and Solutions (Chapter 3)* — Refer to this table if your plotter and computer work all right by themselves, but you can't get them to work as a team.

*Plotter/Software Symptoms and Solutions (Chapter 4)* — Refer to this table if you are having trouble using a graphics software package with your plotter and computer.

*Pen and Paper Symptoms and Solutions (Chapter 5)* — Refer to this table if you are having a problem that seems related to the plotter pens or paper.

## Returning Your Plotter for Service

If your plotter requires servicing, contact the Hewlett-Packard Dealer or HP Sales and Support Office where you purchased the plotter for complete service information.

If you need to ship your plotter, be sure it is packed in a protective carton. We recommend that you save the original shipping container for this purpose. If needed, packaging materials and carton may be obtained from Hewlett-Packard. In-transit damage is not covered by the warranty. We suggest that you always insure shipments.

You can help assure effective servicing of your plotter by following these guidelines:

1. Follow the instructions in this manual to make certain the malfunction is in your plotter and not the result of an interface

error or a malfunction in your computer or software. If possible, identify the defective area or function.

2. If you determine that repair is required, please include the following items when you return your plotter for service:
  - a. A description of the exact configuration at the time of the malfunction, including the interface cable, computer and peripherals, and software (program) in use.
  - b. A brief description of symptoms for service personnel.
  - c. Hardcopy graphics produced on the plotter that might help illustrate the problem area.
  - d. The serial number of the plotter (located on the bottom panel).
  - e. If purchased through an HP dealer, a copy of the sales slip or other proof of purchase to establish the warranty coverage period.
3. Include your name, address, and a phone number where you may be reached during the day.
4. Do not include any operating accessories with the plotter, unless the problem relates to an accessory. Do include the pen carousel and power supply.



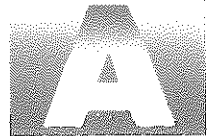

# Specifications

## List of Specifications

### Functional

#### *Media Sizes*

210 × 297 mm (ISO A4)  
8½ × 11 in. (ANSI A)

#### *Media*

Regular plotter paper, glossy presentation paper, fast-dry overhead transparency film

#### *Pens*

8 fiber-tip pens, automatic pen changing and capping

#### *Maximum Plotting Area*

Y-axis: 191 mm (7.5 in.) for A- and A4-size paper  
X-axis: 257 mm (10.1 in.) for A-size paper  
272 mm (10.7 in.) for A4-size paper

#### *Resolution*

Addressable step size: 0.025 mm (0.001 in.)

#### *Pen Velocity*

Pen up: 52 cm/s (20 in./s)  
Pen down: maximum: 40 cm/s (16 in./s)  
programmable: 1 to 40 cm/s in 1 cm/s increments

## Functional (Continued)

### *Acceleration*

Approximately 1.2 g's

## Interface Options

### *RS-232-C/CCITT V.24*

Asynchronous serial, ASCII, 60-byte buffer size

Switch selectable baud rates: 75-9600 (see Appendix B for list of rates)

Switch selectable parity: odd, even, or off

### *HP-IB*

HP-IB functions as defined in Appendix B

Switch selectable addresses: 0-31 (31 sets listen-only mode)

## Physical

### *Size*

Depth: 308 mm (12.13 in.)

Width: 460 mm (18.11 in.)

Height: 125 mm (4.92 in.)

### *Weight*

Plotter: 4.1 kg (9 lb)

Power Supply: 1.4 kg (3 lb)

## Environmental

### *Operating*

Temperature: 0° C to 55° C

Humidity: 5-95% (at 40° C)

### *Nonoperating*

Temperature: -40° C to 75° C

## Power

### *Requirements*

Source: 100, 120, 220, 240 V~ -10%, +5%

Frequency: 48-66 Hz

Consumption: 20 W maximum

**Power (Continued)**

**Options**

The power supply/cord supplied with your plotter should match the plug requirement for your area. However, power cords with different plugs (international options) are available and are shown by the following chart. If you wish to use a different power supply/cord, contact your local Hewlett-Packard dealer or Sales and Support Office.

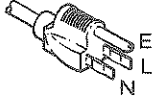
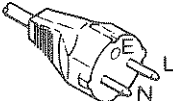
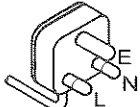
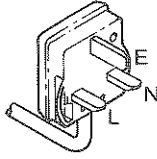

*Power Supply Options*

| AC Plug Type*   | AC Voltage | Country  | HP Model Number |
|---|------------|--|-----------------|
| <br>NEMA 5-15P | 100 V      | Japan<br>Korea   | 17322A          |
|   | 120 V      | United States<br>Canada<br>Philippines<br>Mexico<br>Taiwan | 17122A          |
| <br>CEE 7-VII  | 220 V      | East and West<br>Europe<br>Saudi Arabia<br>Egypt<br>Spain  | 17222A          |
| <br>SABS 164   | 220 V      | Libya<br>India<br>South Africa                             | 17622A          |
| <br>BS 1363A   | 240 V      | Sudan<br>Singapore<br>Cyprus<br>Nigeria<br>United Kingdom  | 17422A          |

\*L = Line or Active Conductor (also called "live" or "hot")  
 N = Neutral or Identified Conductor  
 E = Earth or Ground

*(Table continues)*

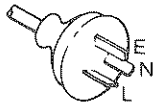
*Power Supply Options (Continued)*

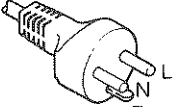
| AC Plug Type*   | AC Voltage | Country  | HP Model Number |
|---|------------|--|-----------------|
| <br>ASC112     | 220 V      | Papua New Guinea<br>People's Republic of China<br>Argentina<br>Uruguay | 17922A          |
|   | 240 V      | Australia<br>New Zealand   | 17722A          |
| <br>SEV 1011   | 220 V      | Switzerland  | 17522A          |
| <br>DHCK-107 | 250V       | Denmark  | 17822A          |

\*L = Line or Active Conductor (also called "live" or "hot")  
 N = Neutral or Identified Conductor  
 E = Earth or Ground

Specifications



## Supplemental Interfacing Information

This appendix provides a summary of RS-232-C and HP-IB specifications, and assumes the reader is already familiar with interface and handshake concepts. For a detailed explanation of your plotter's interface capabilities, refer to the HP ColorPro Programming Manual (Part No. 07440-90001). An application note, *Interfacing and Handshaking Guide* (Part No. 5953-9770) is also available from Hewlett-Packard and contains supplemental material on HP's RS-232-C/CCITT V.24 plotters. Refer to Appendix D for information on ordering the Programming Manual or Application Note.

The following information is included in this appendix:

- Baud Rate Options (RS-232-C)
- Parity Options (RS-232-C)
- Plotter Interface Connector (RS-232-C)
- Cable Schematics (RS-232-C)
- Handshake Information (RS-232-C)
- Address Mode/Options (HP-IB)

## RS-232-C/CCITT V.24 Information

### Baud Rate Options

Baud rate is selected using the **B1**, **B2**, **B3**, and **B4** baud rate switches on the plotter's rear panel. The following table lists the possible baud rates, along with their related switch settings. The plotter is configured to automatically verify and generate one or two stop bits, depending on the setting of the baud rate switches.

*Baud Rate Switch Settings*

| Baud Rate | Switch Settings |    |    |    |             |    |    |    |
|-----------|-----------------|----|----|----|-------------|----|----|----|
|           | 1 Stop Bit      |    |    |    | 2 Stop Bits |    |    |    |
|           | B1              | B2 | B3 | B4 | B1          | B2 | B3 | B4 |
| 75        | —               | —  | —  | —  | 1           | 0  | 0  | 0  |
| 110       | —               | —  | —  | —  | 0           | 1  | 0  | 0  |
| 150       | 1               | 1  | 0  | 0  | —           | —  | —  | —  |
| 200       | 0               | 0  | 1  | 0  | —           | —  | —  | —  |
| 300       | 1               | 0  | 1  | 0  | 1           | 1  | 0  | 1  |
| 600       | 0               | 1  | 1  | 0  | 0           | 0  | 1  | 1  |
| 1200      | 1               | 1  | 1  | 0  | 1           | 0  | 1  | 1  |
| 2400      | 0               | 0  | 0  | 1  | 0           | 1  | 1  | 1  |
| 4800      | 1               | 0  | 0  | 1  | 1           | 1  | 1  | 1  |
| 9600      | 0               | 1  | 0  | 1  | 0           | 0  | 0  | 0  |

### Parity Options

Parity is selected using the **S1** and **S2** parity switches on the rear panel. The following table provides a list of parity switch settings.

*Parity Switch Settings*

| Parity | Switch Settings |         |
|--------|-----------------|---------|
|        | S1              | S2      |
| none   | 0               | 0 or 1* |
| even   | 1               | 0       |
| odd    | 1               | 1       |

\*Setting S2 to 0 sets parity bits sent by the plotter to 0 (space parity); setting S2 to 1 sets the parity bits to 1 (mark parity).

## Plotter Interface Connector

The plotter's RS-232-C connector is a standard DB-25 female connector. The following table provides a listing of the interface pin allocations.

*RS-232-C/CCITT V.24 Pin Allocations*

| Wire/Signal Name    | Pin # | RS-232-C | CCITT V.24 |
|---------------------|-------|----------|------------|
| Protective Ground   | 1     | AA       | 101        |
| Transmitted Data    | 2     | BA       | 103        |
| Received Data       | 3     | BB       | 104        |
| Request to Send     | 4     | CA       | 105        |
| Clear to Send       | 5     | CB       | 106        |
| Data Set Ready      | 6     | CC       | 107        |
| Signal Ground       | 7     | AB       | 102        |
| Data Carrier Detect | 8     | CF       | 109        |
| Data Terminal Ready | 20    | CD       | 108.2      |

## Cable Schematics

The following cable schematics are for Hewlett-Packard cables. All cables use standard 25-pin "D" subminiature connectors except the HP 92221P, which uses a 9-pin "D" subminiature connector on the computer end.

### Modem Eliminator Cable

| HP Cable Number | Connector Type (25-Pin) |              |
|-----------------|-------------------------|--------------|
|                 | Plotter End             | Computer End |
| 17255D          | Male                    | Female       |
| 17255M          | Male                    | Male         |
| 13242G*         | Male                    | Male         |

\*Symmetrical; either end may be connected to the plotter.

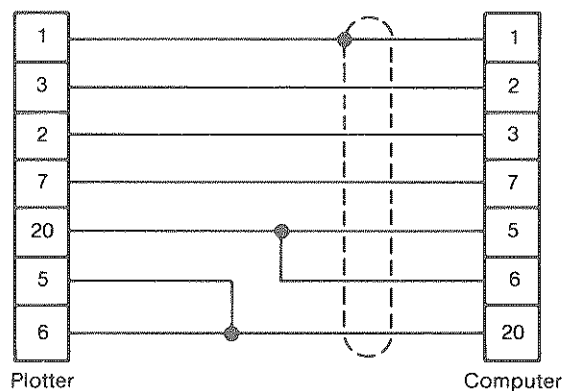

*Modem Eliminator Cable*



| HP Part Number 17302A |                       |
|-----------------------|-----------------------|
| Plotter End           | Macintosh End         |
| Male (25-Pin)         | Male (8-Pin Mini Din) |

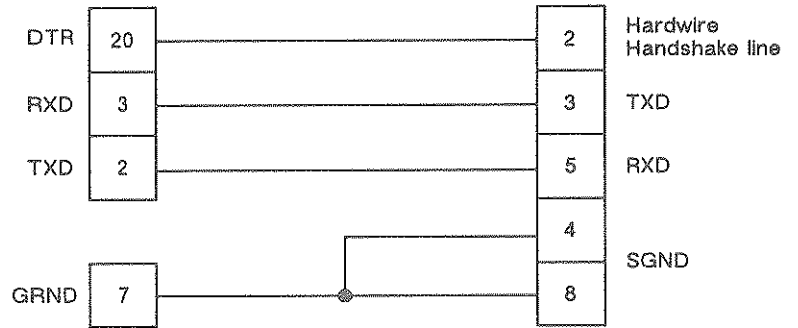

**Straight-through Cable**

| HP Cable Number | Connector Type (25-Pin) |              |
|-----------------|-------------------------|--------------|
|                 | Plotter End             | Computer End |
| 17355F*         | Female                  | Female       |
| 17355M*         | Male                    | Male         |

\*Symmetrical; either end may be connected to the plotter.

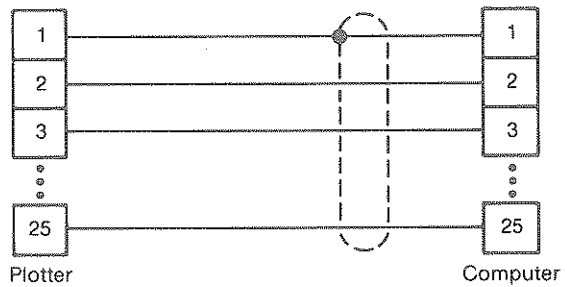

*Straight-through Cable  
(pins 1-25 are directly connected)*

**Special RS-232-C Cables**

| HP Part Number | Connector Type |                |
|----------------|----------------|----------------|
|                | Plotter End    | Computer End   |
| 24542G         | Male (25-pin)  | Female (9-Pin) |

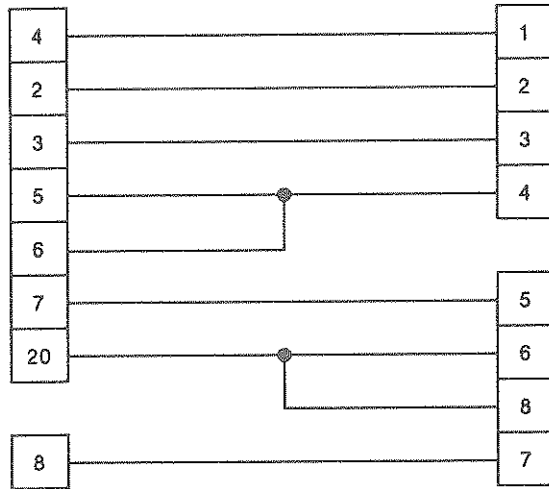

| HP Part Number | Connector Type |              |
|----------------|----------------|--------------|
|                | Plotter End    | Computer End |
| 92219M         | Male (25-pin)  | Male (9-Pin) |

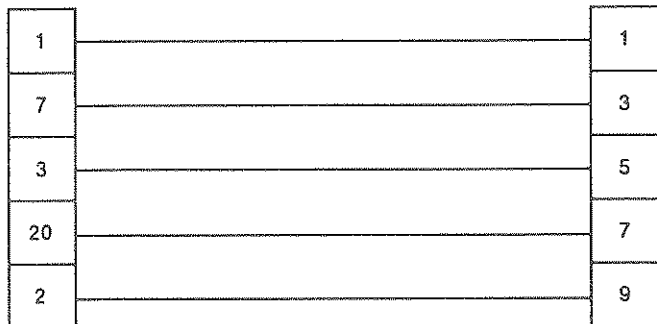

Interfacing Info.

### Serial Printer Cable (9-Pin to 25-Pin)

| HP Part Number | Connector Type |               |
|----------------|----------------|---------------|
|                | Computer End   | Plotter End   |
| 92221P         | Male (9-pin)   | Male (25-Pin) |

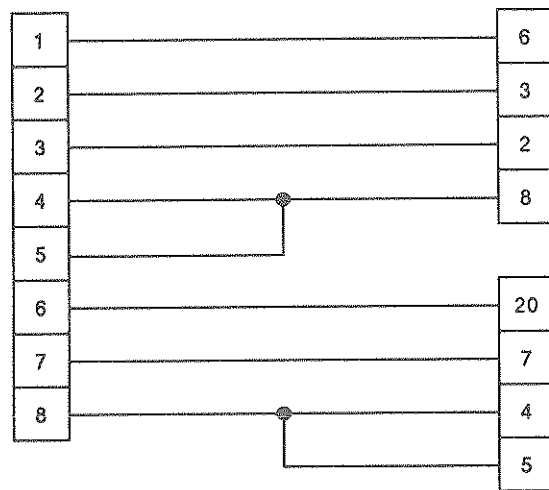

*Serial Printer Cable*

### Handshake Information

If your plotter has an RS-232-C interface, it is capable of using any one of four handshake methods; hardware handshake, Xon/Xoff handshake, enquire/acknowledge handshake, or software checking handshake. Hardware handshake is automatically established when the plotter is turned on. Hardware handshake can be used if the computer system can or does monitor pin 20 (DTR) of the plotter through the interface cable. Most personal computers use hardware handshake. In all cases, the handshake you use will be dictated by your computer system's capabilities and requirements.

If you need information on establishing Xon/Xoff, enquire/acknowledge, or software checking handshake, consult the HP ColorPro Programming Manual (Part No. 07440-90001). The Programming Manual also explains how to use device-control instructions to establish the plotter's handshake protocol.

## HP-IB

The HP-IB interface conforms to ANSI/IEEE 488-1978 specifications. The following table lists the functions implemented on your plotter.

| Interface Function Name | Plotter Implementation |
|-------------------------|------------------------|
| Source Handshake        | SH1                    |
| Acceptor Handshake      | AH1                    |
| Talker                  | T6                     |
| Listener                | L3                     |
| Service Request         | SR1                    |
| Parallel Poll*          | PP1, PP2, or PP0       |
| Device Clear            | DC1                    |

\*PP1 if address  $\geq$  8; PP2 if address  $<$  8; PP0 if listen-only mode.

### Address/Mode Options

The HP-IB address is selected using the rear-panel address switches. The plotter can be set to any one of 31 addresses with address 31 setting listen-only mode. The plotter is set to an address code of 05 at the factory. The following table lists the available address switch positions for each value.

HP-IB Address Settings

| Address Switch Settings |   |   |   |   | Address Codes |       | Address Characters |      |
|-------------------------|---|---|---|---|---------------|-------|--------------------|------|
| 16                      | 8 | 4 | 2 | 1 | Decimal       | Octal | Listen             | Talk |
| 0                       | 0 | 0 | 0 | 0 | 0             | 0     | SP                 | @    |
| 0                       | 0 | 0 | 0 | 1 | 1             | 1     | !                  | A    |
| 0                       | 0 | 0 | 1 | 0 | 2             | 2     | "                  | B    |
| 0                       | 0 | 0 | 1 | 1 | 3             | 3     | #                  | C    |
| 0                       | 0 | 1 | 0 | 0 | 4             | 4     | \$                 | D    |
| 0                       | 0 | 1 | 0 | 1 | 5             | 5     | %                  | E    |
| 0                       | 0 | 1 | 1 | 0 | 6             | 6     | &                  | F    |
| 0                       | 0 | 1 | 1 | 1 | 7             | 7     | '                  | G    |
| 0                       | 1 | 0 | 0 | 0 | 8             | 10    | (                  | H    |
| 0                       | 1 | 0 | 0 | 1 | 9             | 11    | )                  | I    |
| 0                       | 1 | 0 | 1 | 0 | 10            | 12    | *                  | J    |
| 0                       | 1 | 0 | 1 | 1 | 11            | 13    | +                  | K    |
| 0                       | 1 | 1 | 0 | 0 | 12            | 14    | ,                  | L    |
| 0                       | 1 | 1 | 0 | 1 | 13            | 15    | -                  | M    |
| 0                       | 1 | 1 | 1 | 0 | 14            | 16    | .                  | N    |
| 0                       | 1 | 1 | 1 | 1 | 15            | 17    | /                  | O    |
| 1                       | 0 | 0 | 0 | 0 | 16            | 20    | 0                  | P    |
| 1                       | 0 | 0 | 0 | 1 | 17            | 21    | 1                  | Q    |
| 1                       | 0 | 0 | 1 | 0 | 18            | 22    | 2                  | R    |
| 1                       | 0 | 0 | 1 | 1 | 19            | 23    | 3                  | S    |
| 1                       | 0 | 1 | 0 | 0 | 20            | 24    | 4                  | T    |
| 1                       | 0 | 1 | 0 | 1 | 21            | 25    | 5                  | U    |
| 1                       | 0 | 1 | 1 | 0 | 22            | 26    | 6                  | V    |
| 1                       | 0 | 1 | 1 | 1 | 23            | 27    | 7                  | W    |
| 1                       | 1 | 0 | 0 | 0 | 24            | 30    | 8                  | X    |
| 1                       | 1 | 0 | 0 | 1 | 25            | 31    | 9                  | Y    |
| 1                       | 1 | 0 | 1 | 0 | 26            | 32    | :                  | Z    |
| 1                       | 1 | 0 | 1 | 1 | 27            | 33    | ;                  | [    |
| 1                       | 1 | 1 | 0 | 0 | 28            | 34    | <                  | \    |
| 1                       | 1 | 1 | 0 | 1 | 29            | 35    | =                  | ]    |
| 1                       | 1 | 1 | 1 | 0 | 30            | 36    | >                  | ^    |
| 1                       | 1 | 1 | 1 | 1 | 31            | 37    | ?                  | -    |

← Preset

← Reserved for HP desktop computer address

← Sets listen-only mode

## Notes

---

Interfacing Info.



## The Graphics Enhancement Cartridge

The Graphics Enhancement Cartridge (HP 17440) gives you additional plotting capabilities. With the cartridge installed, you can use your plotter with software packages that require the cartridge's additional capabilities. Your software documentation should tell you if the cartridge is required. The plotter's front-panel operations are *not* affected by the addition of the cartridge.

If you are writing your own graphics programs, having the cartridge installed allows you to use 14 additional HP-GL instructions. The additional instructions make it easy to:

- draw arcs and circles
- outline and fill polygons
- use 14 more character sets (including ISO character sets)

Additionally, the cartridge gives the plotter extended RS-232-C handshaking capability, including an I/O buffer size of 1024 bytes (programmable to 1974 bytes). The HP ColorPro Programming Manual (Part No. 07440-90001) includes information on using the HP-GL programming instructions provided by the cartridge.

Information on ordering the Graphics Enhancement Cartridge and/or Programming Manual is included in Appendix D of this manual.

## Installing the Cartridge

---

### CAUTION

Installing the cartridge without first unplugging the power supply cord may damage the cartridge.

---

1. Unplug the power supply cord from the wall outlet.

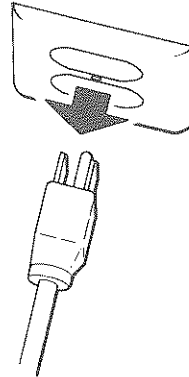

2. Swing the cartridge's locking handle up so that you can grasp it.

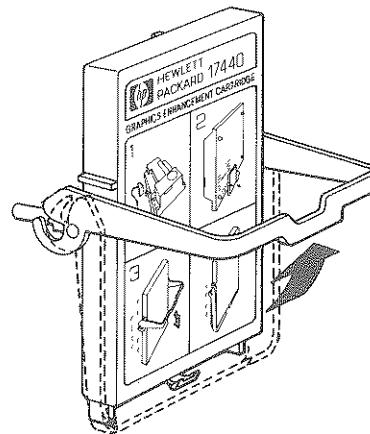



3. Holding the cartridge by the handle, insert the plastic posts on the cartridge into the slot on the bottom of the plotter. Make certain the posts are lined up with their receptacles on the plotter.

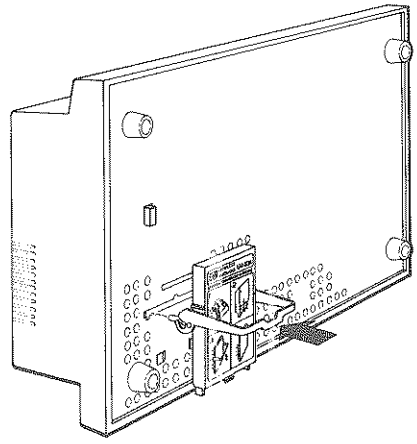

4. Swing the cartridge's locking handle down.

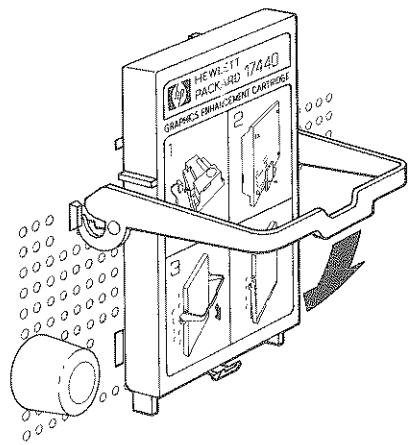

5. Press the handle in until it snaps into place.

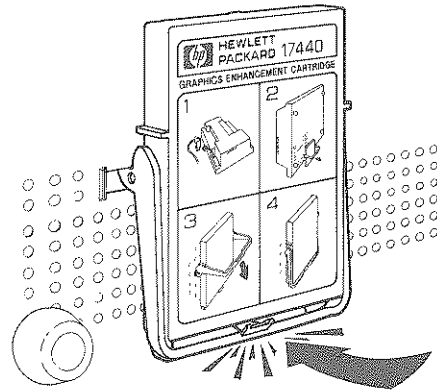

- 6. Connect the power supply, load pens and paper, and perform the built-in demonstration plot as described in Chapter 1, *Setting Up Your Plotter*. If the cartridge is correctly installed and functioning the demonstration plot will appear as shown below.

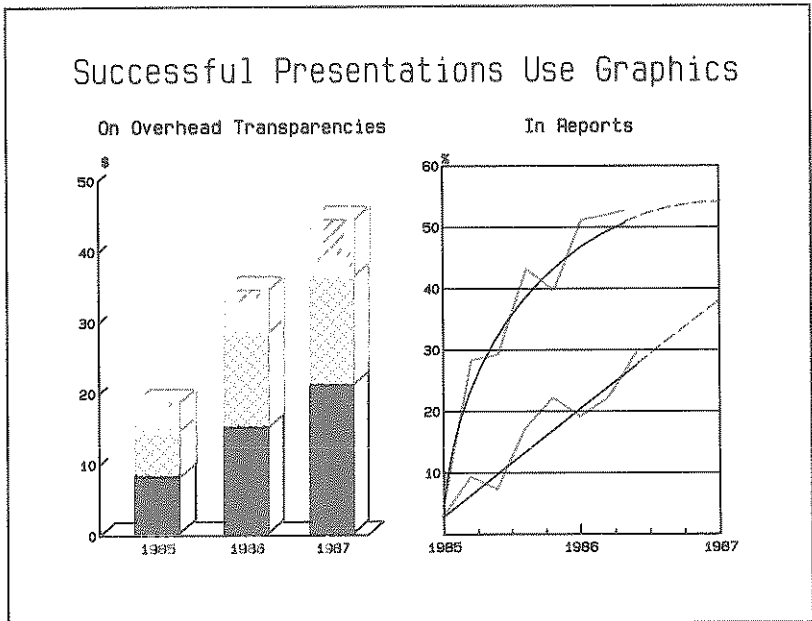

## Notes

---



## Accessories Available

### List of Accessories Available

The following items are available for your plotter and can be ordered from Hewlett-Packard by using the appropriate part number. (Ordering information follows this listing.) For information on available pen and paper supplies, refer to the *Supplies and Cables* brochure, shipped with your plotter.

| Item                           | HP Model or Part Number |
|--------------------------------|-------------------------|
| Graphics Enhancement Cartridge | 17440A                  |
| Programming Manual             | 07440-90001             |
| Pocket Guide                   | 07440-90003             |
| Service Manual                 | 07440-90000             |
| Operating Manual               |                         |
| English                        | 07440-90002             |
| German                         | 07440-90004             |
| French                         | 07440-90005             |
| Spanish                        | 07440-90006             |
| Italian                        | 07440-90007             |
| Japanese                       | 07440-90008             |
| Power Supply                   | See Appendix A          |
| RS-232-C Test Plug*            | 07440-60302             |

\*The test plug is used for diagnostic testing of the RS-232-C interface on the RS-232-C ColorPro Graphics Plotter. Instructions for use are included in the service manual.

(Table continues)

| Item   | HP Model or Part Number                            |
|--|--|
| RS-232-C Cable (for use with HP Touchscreen, HP 150, or Sirius I personal computers)           | 13242G   |
| RS-232-C Cable (for use with personal computers)   | 17255D<br>24542G                                   |
| RS-232-C Cable (for use with Apple IIe and II Plus, Apple III, and DEC 350 personal computers) | 17355M   |
| RS-232-C Cable (for use with Apple Macintosh Plus, II, and SE computers)                       | 17302A   |
| RS-232-C Cable (for use with Apple Macintosh Computer)   | 92219M   |
| HP-IB Cable (IEEE 488-1978); RFI shielded  | 10833A, B, C, or D*<br>(1, 2, 4, or 5 metres long) |
| 8-Pen Carousel (Fiber-Tip)   | 07440-60085  |
| Dust Cover   | 07440-60006  |
| Vinyl Carrying Case (not suitable for shipping)  | 07440-60001  |
| Transit Case   | 07440-60009  |

\*The 10833 HP-IB cables will replace and are identical to the 31389 and 45529 series HP-IB cables.

## The Programming Manual

The HP ColorPro Programming Manual (Part No. 07440-90001) available for your plotter contains complete explanations and examples of the plotter's graphics and interfacing instructions. It begins with discussions of various programming languages and how to use them with the plotter's instruction set, HP-GL (Hewlett-Packard Graphics Language).

The manual also documents the additional interfacing capabilities and HP-GL instructions (arcs, circles, and polygons) available with the add-on Graphics Enhancement Cartridge.

The HP ColorPro Pocket Guide (Part No. 07440-90003) is also available. The Pocket Guide is intended for those who are already familiar with the information contained in the Programming Manual, and who need a convenient reference when programming in HP-GL.

---

## How to Order Supplies and Accessories

You can order plotter supplies and accessories in any of these three ways:

- Call your local authorized HP dealer.
- Contact your local HP Sales and Support Office.
- In the United States, use HP's Direct Order telephone service. The telephone number is provided in the *Supplies and Cables* brochure, shipped with your plotter.

For a complete list of Hewlett-Packard supplies and accessories, order the Hewlett-Packard Computer User's Catalog (Part No. 5953-2450). You can obtain one by asking at your local HP Sales and Support Office. You can also obtain an English version by filling out and returning the comment card found at the front of this manual.

## Notes

---

Accessories



## Glossary

**Address** — A switch-selectable number assigned to the plotter when using an HP-IB interface. The address specifies the device location on the HP-IB bus.

**BASIC** — Beginner's All-purpose Symbolic Instruction Code; a programming language which uses common English words.

**Baud Rate** — For RS-232-C, data transmission rate between a computer and peripheral device. A baud is equal to one bit per second.

**Bit** — Binary digit; a bit represents an "on" or "off" electrical condition and is the smallest unit of digital information sent through the interface.

**Buffer** — A temporary part of the computer or plotter's memory where data (HP-GL instructions, for example) is held until it can be processed.

**Configuration** — A group of computer equipment that is interconnected and is set up to operate as a system.

**Default** — A value or condition that is assumed if no other value or condition is specified.

**Graphics Software Package** — A commercially-available computer program that can be run in a computer and used to create graphics on the plotter.

**HP-GL Instructions** — Hewlett-Packard Graphics Language; the graphics instruction set the plotter understands.

**HP-IB** — A type of interface; your plotter uses either an HP-IB or an RS-232-C interface, identified by the connector on the rear of the plotter.

**Handshaking** — For RS-232-C, a method of communication between a computer and plotter concerning the availability of buffer space (memory) in the plotter.

## Glossary (Continued)

**Initialize** — To set certain conditions to a known state, usually the device's default state. Your plotter initializes when it is first turned on.

**Interface** — Anything (a cable, for example) used to join components of a computer system so that they are able to function in a compatible and coordinated fashion.

**Interface Cable** — The cable used to connect the plotter to a computer. Data is transmitted through the cable. Your plotter requires either an RS-232-C or an HP-IB interface cable, depending upon which type of interface connector the plotter has.

**Parity** — For RS-232-C, an error-checking method for information transfer between computer and a device. Parity can be used to check the accuracy of a binary data byte (character).

**Peripheral** — A device that enhances computer performance; a disc drive, printer, or plotter, for example.

**P1** — A scaling point the plotter uses that generally specifies the location of a plot's lower-left corner.

**P2** — A scaling point the plotter uses that generally specifies the location of a plot's upper-right corner.

**RS-232-C** — A type of interface; your plotter uses either an RS-232-C or an HP-IB interface, identified by the connector on the rear of the plotter.

## Subject Index

### A

---

AT&T PC 6300, plotter  
and 3-16  
Address, table of switch  
settings B-8  
Address switches, HP-IB  
and 4-3  
Apple IIc computer, plotter  
and 3-10  
Apple IIe/II Plus computers,  
plotter and 3-7  
Apple III computer, plotter  
and 3-13  
Apple Macintosh computers,  
plotter and 3-16

### B

---

Baud rate  
RS-232-C and 4-2  
table of switch settings B-2

### C

---

Cable, interface 3-1, 3-5,  
B-4-B-6  
Carousel, loading and  
unloading 1-10  
Cleaning, plotter, *see*  
Maintenance  
Commodore Amiga Personal  
computers, plotter and 3-18  
Compaq computer, plotter inter-  
connection and 3-18  
Computer, list of  
interconnections 3-5  
Confidence test *see* Demonstra-  
tion plot  
Configuring a computer 3-2  
Cursor Control buttons,  
using the 2-5

### D

---

DEC Professional 350 computer,  
plotter and 3-21  
Demonstration plot 1-12-1-13  
Digitizing 2-10

### E

---

Enter button, using the 2-10

### F

---

Film, overhead transparency,  
*see* Transparency film  
Front-Panel controls, table  
of 2-3

### G

---

Graphics programs, writing 4-4  
Graphics software packages,  
using 4-1

### H

---

HP Portable computer, plotter  
and 3-24, 3-27  
HP Series 200 computers, plotter  
and 3-30  
HP Touchscreen (HP 150) com-  
puter, plotter and 3-32, 3-35  
HP-GL instructions 3-1, D-4  
HP-IB address switch  
settings B-8  
HP-IB interface 3-4, B-7  
Handshake options B-6

### I

---

IBM Personal computers, plotter  
and 3-38  
Installing software 4-1-4-3  
Interface types, plotter 3-4

## Subject Index (Continued)

### L

---

Labels, creating 4-4  
Load button, using the 2-4

### M

---

Maintenance, plotter 6-1  
Media, *see* Paper

### O

---

Olivetti M24 computer, plotter  
and 3-41  
On/Off button, using the 2-4  
Overhead transparency film,  
*see* Transparency film

### P

---

P1 and P2  
buttons, using the 2-6  
defined 2-6  
Paper  
loading and unloading 1-11  
types of 5-1  
Parity B-2  
Pen problems, *see* Symptoms  
and solutions, pen and paper  
Pen Select button, using the 2-5  
Pen speeds  
changing 5-4  
recommended 5-1, 5-4  
Pen Up/Down button,  
using the 2-6  
Pen/Paper combinations,  
selecting 5-1  
Pens  
caring for 5-4  
loading 1-7  
types of 5-3

### Plotter

maintenance 6-1  
problems, *see* Symptoms and  
solutions, plotter  
returning for service 6-3  
Power supply  
connecting the 1-5  
options A-3  
Programs, writing graphics 4-4

### R

---

Rotating Plots 2-8  
RS-232-C  
baud rates B-2  
cable schematics B-4  
interface 3-4, B-2

### S

---

Sample plot *see* Demonstration  
plot  
Shipping the plotter, *see* Plotter,  
returning for service  
Sirius 1 computer, plotter  
and 3-43  
Software packages, using 4-1  
Speed, changing the pen 5-4  
Switch settings B-2  
Symptoms and solutions  
plotter 1-14  
plotter/computer 3-6  
plotter/software 4-4  
paper/pen 5-5

### T

---

Test program 3-3  
Transparency film 5-2  
Transparency pens 5-3  
Troubleshooting, *see* Symptoms  
and solutions

### V

---

View button, using the 2-6